

BenQ

SP830/SP831 Digital Projector

User Manual

Welcome

Table of contents

Important safety instructions	5
Introduction	9
Projector features	9
Shipping contents	10
Standard accessories	10
Optional accessories	10
Projector exterior view.....	11
Controls and functions	12
Projector	12
Remote control.....	13
Positioning your projector.....	17
Choosing a location	17
Obtaining a preferred projected picture size	18
How to determine the position of the projector for a given screen size ...	18
How to determine the recommended screen size for a given distance	19
Projection dimensions	20
Connection	23
Connecting a computer	23
Connecting a monitor	24
Connecting Video source devices	25
Connecting Audio device	29
Operation.....	30
Starting up the projector	30
Using the menus.....	31
Securing the projector.....	32
Using a security cable lock	32
Utilizing the password function	32
Switching input source	35
Adjusting the projected picture.....	36
Adjusting the projection angle	36
Auto-adjusting the picture	36
Fine-tuning the picture size and clarity	36
Correcting picture distortion	37
Selecting the aspect ratio.....	39

Magnifying and Searching for details on the projected picture.....	41
Selecting a picture mode	42
Fine-tuning the picture quality.....	45
Advanced picture quality controls.....	46
Operating in a high altitude environment	50
Hiding the picture	50
Displaying more than one picture source simultaneously	51
Splitting the screen	51
PIP (Picture In Picture) operation	52
Creating your own startup screen	54
Personalizing the projector menu display	54
Adjusting the sound	55
Remote paging operations	56
Freezing the picture	56
Locking control keys	56
Shutting down the projector.....	57
Menu operation.....	58
Menu system	58
Picture -- Basic menu	61
Picture -- Advanced menu.....	62
Display menu	63
System Setup menu	64
Advanced Setup menu.....	65
Information menu	66
Maintenance	67
Care of the projector	67
Cleaning the lens	67
Cleaning the projector case	67
Storing the projector	67
Transporting the projector	67
Lamp information	68
Getting to know the lamp hour	68
Extending lamp life	68
Timing of replacing the lamp.....	69
Replacing the lamp	70
Indicators	73
Troubleshooting.....	74

Specifications	76
Projector specifications	76
Timing chart.....	77
Dimensions	78
Warranty and Copyright information	79
Regulation statements	80

1. Important safety instructions

Your BenQ projector is designed and tested to meet the latest standards for safety of information technology equipment. However, to ensure safe use of this product, it is important that you follow the instructions mentioned in this manual and marked on the product.

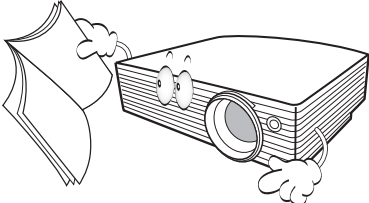
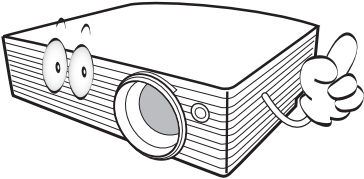
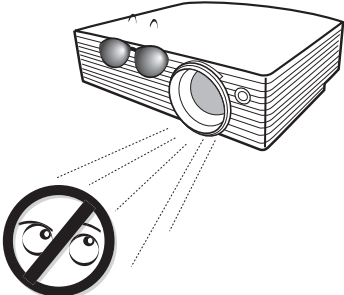
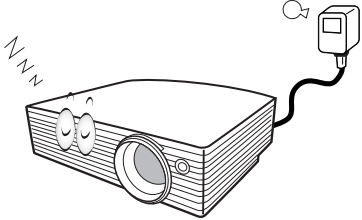
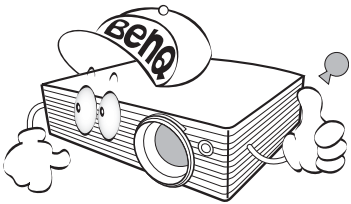
Safety Instructions	
<p>1. Please read this manual before you operate your projector. Save it for future reference.</p> 	<p>4. Always open the lens shutter or remove the lens cap when the projector lamp is on.</p> 
<p>2. Do not look straight at the projector lens during operation. The intense light beam may damage your eyes.</p> 	<p>5. In some countries, the line voltage is NOT stable. This projector is designed to operate safely within a mains voltage between 100 to 240 volts AC, but could fail if power cuts or surges of ± 10 volts occur. In areas where the mains voltage may fluctuate or cut out, it is recommended that you connect your projector through a power stabilizer, surge protector or uninterruptible power supply (UPS).</p> 
<p>3. Refer servicing to qualified service personnel.</p> 	<p>6. Do not block the projection lens with any objects when the projector is under operation as this could cause the objects to become heated and deformed or even cause a fire. To temporarily turn off the lamp, press BLANK on the projector or remote control.</p>

Safety Instructions (Continued)

7. The lamp becomes extremely hot during operation. Allow the projector to cool for approximately 45 minutes prior to removing the lamp assembly for replacement.

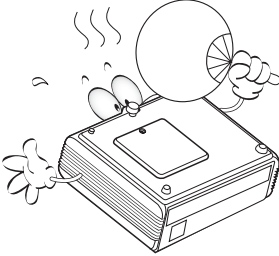

8. Do not operate lamps beyond the rated lamp life. Excessive operation of lamps beyond the rated life could cause them to break on rare occasions.

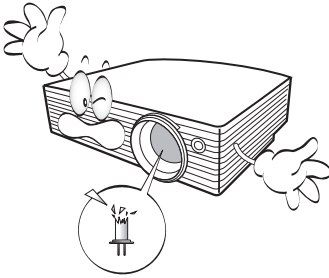

9. Never replace the lamp assembly or any electronic components unless the projector is unplugged.

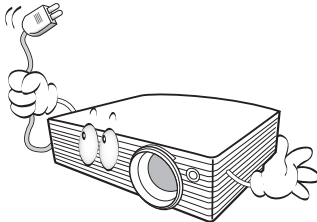

10. Do not place this product on an unstable cart, stand, or table. The product may fall, sustaining serious damage.

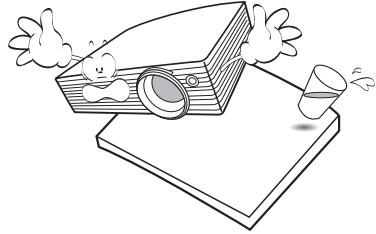

11. Do not attempt to disassemble this projector. There are dangerous high voltages inside which may cause death if you should come into contact with live parts. The only user serviceable part is the lamp which has its own removable cover.

Under no circumstances should you ever undo or remove any other covers. Refer servicing only to suitably qualified professional service personnel.

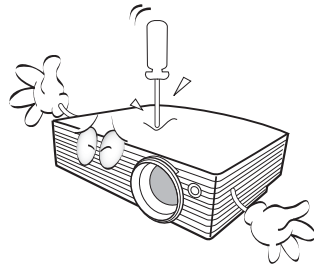

12. When the projector is under operation, you may sense some heated air and odor from its ventilation grill. It is a normal phenomenon and not a product defect.

Safety Instructions (Continued)

13. Do not place this projector in any of the following environments.
- Space that is poorly ventilated or confined. Allow at least 50 cm clearance from walls and free flow of air around the projector.
 - Locations where temperatures may become excessively high, such as the inside of a car with all windows rolled up.
 - Locations where excessive humidity, dust, or cigarette smoke may contaminate optical components, shortening the projector's life span and darkening the picture.

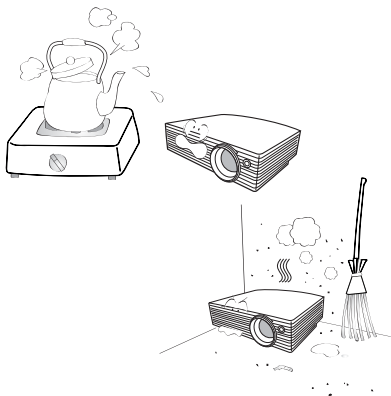

- Locations near fire alarms
- Locations with an ambient temperature above 35°C / 95°F
- Locations where the altitudes are higher than 1500 m / 4920 feet.

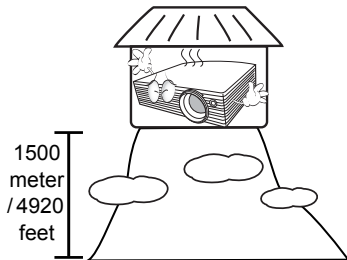

14. Do not block the ventilation holes.
- Do not place this projector on a blanket, bedding or any other soft surface.
 - Do not cover this projector with a cloth or any other item.
 - Do not place inflammables near the projector.

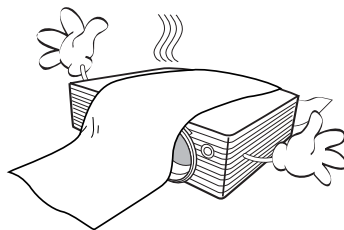

If the ventilation holes are seriously obstructed, overheating inside the projector may result in a fire.

15. Always place the projector on a level, horizontal surface during operation.
- Do not use if tilted at an angle of more than 40 degrees left to right, nor at angle of more than 35 degrees front to back. Using the projector when it is not fully horizontal may cause a malfunction of, or damage to, the lamp.

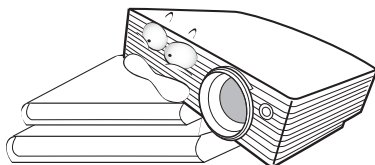

Safety Instructions (Continued)

16. Do not stand the projector on end vertically. Doing so may cause the projector to fall over, causing injury or resulting in damage to the projector.

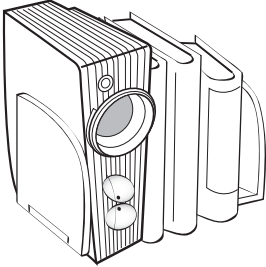

17. Do not step on the projector or place any objects upon it. Besides probable physical damage to the projector, doing so may result in accidents and possible injury.

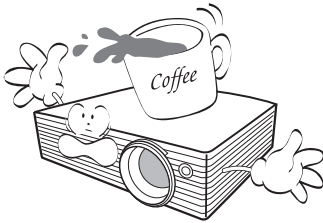

18. Do not place liquids near or on the projector. Liquids spilled into the projector may cause it to fail. If the projector does become wet, disconnect it from the power supply's wall socket and call BenQ to have the projector serviced.

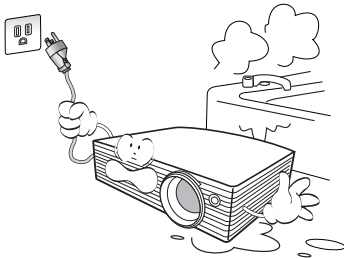

19. This product is capable of displaying inverted pictures for ceiling mount installation.



Use only BenQ's Ceiling Mount Kit for mounting the projector and ensure it is securely installed.

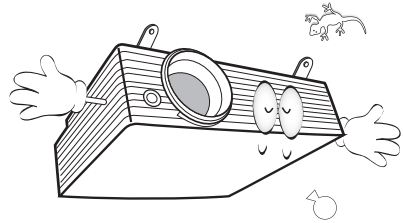

Ceiling mounting the projector

We want you to have a pleasant experience using your BenQ projector, so we need to bring this safety matter to your attention to prevent damage to person and property.

If you intend to mount your projector on the ceiling, we strongly recommend that you use a proper fitting BenQ projector ceiling mount kit and that you ensure it is securely and safely installed.

If you use a non-BenQ brand projector ceiling mount kit, there is a safety risk that the projector may fall from the ceiling due to an improper attachment through the use of the wrong gauge or length screws.

You can purchase a BenQ projector ceiling mount kit from the place you purchased your BenQ projector. BenQ recommends that you also purchase a separate Kensington lock compatible security cable and attach it securely to both the Kensington lock slot on the projector and the base of the ceiling mount bracket. This will perform the secondary role of restraining the projector should its attachment to the mounting bracket become loose.

2. Introduction

Projector features

The projector integrates high-performance optical engine projection and a user-friendly design to deliver high reliability and ease of use.

The projector offers the following features.

- Split Screen and PIP allowing two input sources to be displayed at the same time
- Selectable password protected function
- Off and Go function allowing presenters to unplug the projector right after the projector is turned off
- Up to 9 sets of picture modes providing multiple choices for different projection purposes
- Optional Signal Shuttle module allowing two PC sources to display at the same time
- Optional attachable lens providing more projection size options
- High quality manual zoom lens
- One-key auto-adjustment to display the best picture quality
- Two-way digital keystone correction to correct distorted pictures
- Pincushion and barrel corrections to correct distorted pictures
- A wide variety of inputs for connection to PC and AV equipment
- Panel key lock preventing accidental changes made to the projector settings
- Adjustable color balance control for data/video display
- Ultra-high brightness projection lamp
- Ability to display 1.07 billion colors
- Multi-language On-Screen Display (OSD) menus
- Switchable normal and Economic modes to reduce the power consumption
- Built-in speakers provide stereo sound when an audio input is connected
- Powerful AV function to provide high quality video picture
- Component HDTV compatibility
- ☞ **The apparent brightness of the projected picture will vary depending on the ambient lighting conditions, selected input source contrast/brightness settings, and is directly proportional to projection distance.**
- **The lamp brightness will decline over time and may vary within the lamp manufacturers specifications. This is normal and expected behavior.**

Shipping contents

The projector is shipped with the cables required for connection to a PC or video equipment. Carefully unpack and verify that you have all of the items shown below. If any of these items are missing, please contact your place of purchase or check the most updated accessory list on line at www.BenQ.com.

Standard accessories

 The supplied accessories will be suitable for your region, and may differ from those illustrated.

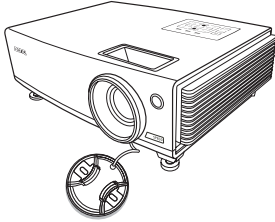

Projector

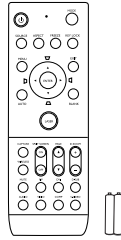

Remote control and two batteries (AAA type)



Multi-language user manual CD



Safety manual



Quick start guide



User manual

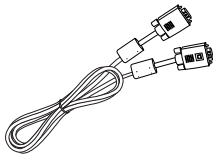

VGA cable

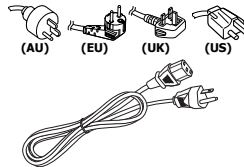

Power cord

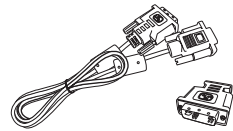

D-Sub-DVI cable
or
DVI to VGA adapter

Optional accessories

- | | |
|----------------------|--------------------|
| 1. Macintosh adapter | 7. Signal shuttle |
| 2. Spare lamp kit | 8. S-Video cable |
| 3. Ceiling mount kit | 9. DVI cable |
| 4. Attachable lens | 10. USB cable |
| 5. Presentation Plus | 11. PC audio cable |
| 6. RS232 connector | |

Projector exterior view

Front/upper side

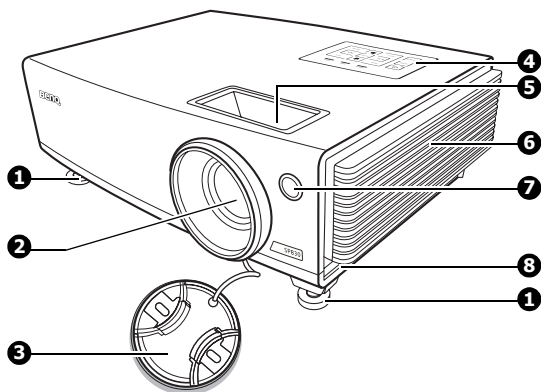

Rear/lower side

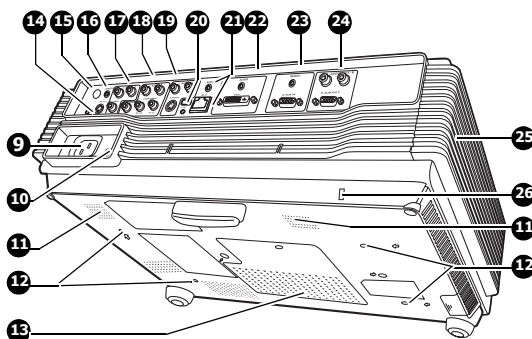

1. Quick-release foot
2. Projection lens
3. Lens cap
4. External control panel
(See pages 12-13 for details.)
5. Focus ring and Zoom ring
6. Vent (cool air intake)
7. Front IR remote sensor
8. Quick-release button
9. AC power cord inlet
10. Main power switch
11. Speaker grill
12. Ceiling mounting holes
13. Lamp cover
14. RS232 control port
15. Rear IR remote sensor
16. Wired remote control port
17. Video/Audio (L/R) input sockets
18. Component video (YPbPr/YCbCr) signal/Audio (L/R) input sockets
19. S-Video/Audio (L/R) input sockets
20. USB socket
21. RJ-45/Audio input sockets
(only for using with the optional Signal Shuttle module)
22. DVI-I signal/PC Audio input sockets
23. D-Sub (RGB) signal/PC Audio input sockets
24. D-Sub (RGB) signal/Audio (L/R) output sockets
25. Vent (heated air exhaust)
26. Kensington anti-theft lock slot

Controls and functions

Projector

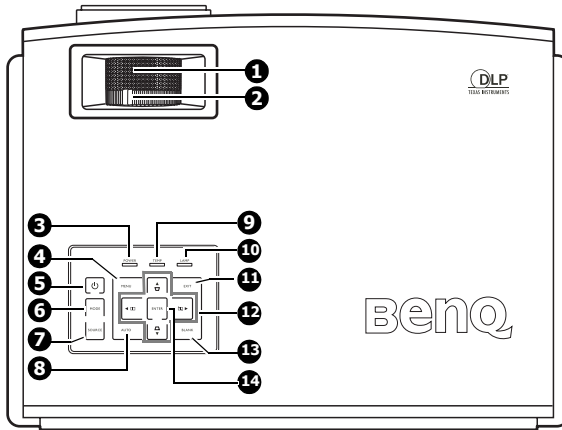

- 1. Focus ring**

Adjusts the focus of the projected picture. See ["Fine-tuning the picture size and clarity" on page 36](#) for details.
- 2. Zoom ring**

Adjusts the size of the picture. See ["Fine-tuning the picture size and clarity" on page 36](#) for details.
- 3. Power indicator light**

Lights up or flashes when the projector is under operation. See ["Indicators" on page 73](#) for details.
- 4. MENU**

Turns on the On-Screen Display (OSD) menu. When the OSD menu is activated, exits and saves the menu settings. See ["Using the menus" on page 31](#) for details.
- 5. Power**

Toggles the projector between standby mode and on.
See ["Starting up the projector" on page 30](#) and ["Shutting down the projector" on page 57](#) for details.
- 6. MODE**

Depending upon which input source is selected, selects an available picture setup mode. See ["Picture Mode" on page 61](#) for details.
- 7. SOURCE**

Displays the source selection bar and makes selection. See ["Switching input source" on page 35](#) for details.
- 8. AUTO**

Automatically determines the best picture timings for the displayed picture.
See ["Auto-adjusting the picture" on page 36](#) for details.
- 9. Temperature warning light**

Lights up if the projector's temperature becomes too high. See ["Indicators" on page 73](#) for details.

Remote control

- 10. Lamp indicator light**
Indicates the status of the lamp. Lights up when the lamp has developed a problem. See ["Indicators" on page 73](#) for details.
- 11. EXIT**
Goes back to previous OSD menus, exits and saves menu settings. See ["Using the menus" on page 31](#) for details.
- 12. Keystone/Arrow keys (▾ / ▲, ▽ / ▼)
Split Screen/Arrow keys (□ / ◀, ▣ / ▶)**
Manually corrects distorted pictures resulting from an angled projection. Turns the split screen function on or off.
When the On-Screen Display (OSD) menu is activated, the keys are used as directional arrows to select the desired menu items and to make adjustments. See ["Correcting picture distortion" on page 37](#), ["Displaying more than one picture source simultaneously" on page 51](#), and ["Using the menus" on page 31](#) for details.
- 13. BLANK**
Used to hide the screen picture. See ["Hiding the picture" on page 50](#) for details.
- 14. ENTER**
Enacts the selected On-Screen Display (OSD) menu item. See ["Using the menus" on page 31](#) for details.

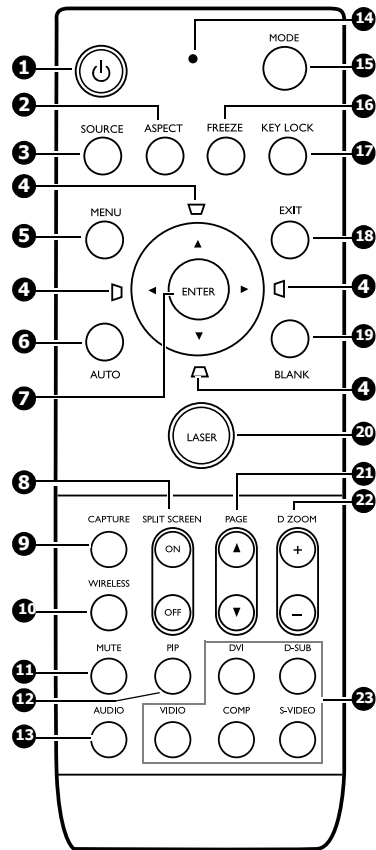

- 1. Power**
Toggles the projector between standby mode and on.
See ["Starting up the projector" on page 30](#) and ["Shutting down the projector" on page 57](#) for details.
- 2. ASPECT**
Selects the display aspect ratio. See ["Selecting the aspect ratio" on page 39](#) for details.

3. **SOURCE**
Displays the source selection bar. See ["Switching input source" on page 35](#) for details.
4. **Keystone/Arrow keys** (◻ / ▲ , ◻ / ◀ , ◻ / ▼ , ◻ / ▶)
Manually correct distorted pictures resulting from an angled projection. When the On-Screen Display (OSD) menu is activated, the keys are used as directional arrows to select the desired menu items and to make adjustments. See ["Correcting picture distortion" on page 37](#) and ["Using the menus" on page 31](#) for details.
5. **MENU**
Turns on the On-Screen Display (OSD) menu. When the OSD menu is activated, exits and saves the menu settings. See ["Using the menus" on page 31](#) for details.
6. **AUTO**
Automatically determines the best picture timings for the displayed picture. See ["Auto-adjusting the picture" on page 36](#) for details.
7. **ENTER**
Enacts the selected On-Screen Display (OSD) menu item. See ["Using the menus" on page 31](#) for details.
8. **SPLIT SCREEN (ON/OFF)**
Turns the split screen function on or off. See ["Splitting the screen" on page 51](#) for details.
9. **CAPTURE**
Captures the projected picture and save it as your startup screen. See ["Creating your own startup screen" on page 54](#) for details.
10. **WIRELESS**
(This function is not available with the SP830/S831.)
11. **MUTE**
Toggles projector audio between on and off.
12. **PIP**
Turns the Picture In Picture (PIP) window on or off. See ["PIP \(Picture In Picture\) operation" on page 52](#) for details.
13. **AUDIO**
Displays the **Audio** menu. See ["Adjusting the sound" on page 55](#) for details.
14. **Indicator light**
Flashes or lights red when any key on the remote control is pressed.
15. **MODE**
Depending upon which input source is selected, selects an available picture setup mode. See ["Selecting a picture mode" on page 42](#) for details.
16. **FREEZE**
The picture is frozen when **FREEZE** is pressed. See ["Freezing the picture" on page 56](#) for details.
17. **KEY LOCK**
Locks the keys on the projector and remote control except **LASER** and **EXIT**. See ["Locking control keys" on page 56](#) for details.
18. **EXIT**
Goes back to previous OSD menus, exits and saves menu settings. See ["Using the menus" on page 31](#) for details.
19. **BLANK**
Used to hide the screen picture. See ["Hiding the picture" on page 50](#) for details.

20. LASER

Emits visible laser pointer light for presentation purposes. See "[Operating the LASER pointer](#)" on the right for details.

21. PAGE ▲ (UP) and PAGE ▼ (DOWN)

Operate your display software program (on a connected PC) which responds to page up/down commands (like Microsoft PowerPoint). See "[Remote paging operations](#)" on page 56 for details.

22. DIGITAL ZOOM keys (+, -)

Magnifies or reduces the projected picture size. See "[Magnifying and Searching for details on the projected picture](#)" on page 41 for details.

23. Source selection keys (DVI, D-SUB, VIDEO, COMP., S-VIDEO)

Select the corresponding input source for display. See "[Switching input source](#)" on page 35 for details.

 **DVI selects DVI-D signal only.**

Operating the LASER pointer

The LASER Pointer is a presentation aid for professionals. It emits red colored light when you press it and the indicator lights up red.

The laser beam is visible. It is necessary to press and hold **LASER** for continuous output.

Avoid Exposure
Laser radiation is emitted from this aperture

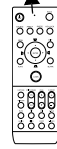

 **Do not look into the laser light window or shine the laser light beam on yourself or others. See the warning messages on the back of the remote control and the enclosed "User Information" prior to using it.**

The laser pointer is not a toy. Parents should be mindful of the dangers of laser energy and keep this remote control out of the reach of children.

Making the remote control a wired control

The remote control is equipped with a jack on the top allowing connection to the projector with a 2.5mm mini jack cable available in the market. This helps you easily locate the remote control when needed as it is connected to the projector and within the distance no greater than the cable's length.

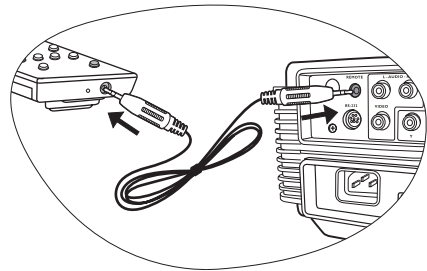

Remote control effective range

Infra-Red (IR) remote control sensors are located on the front and the back of the projector. The remote control must be held at an angle within 30 degrees perpendicular to the projector's IR remote control sensors to function correctly. The distance between the remote control and the sensors should not exceed 6 meters (~ 20 feet).

Make sure that there are no obstacles between the remote control and the IR sensors on the projector that might obstruct the infra-red beam.

- **Operating the projector from the front**

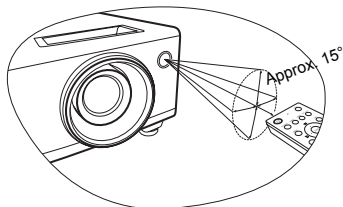

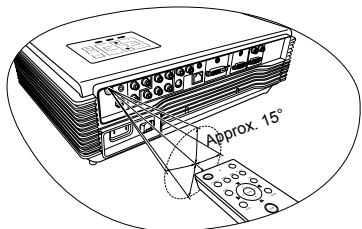

- **Operating the projector from the rear**

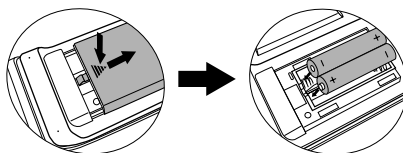

Installing remote control batteries

1. To open the battery cover, turn the remote control over to view its back, push on the finger grip on the cover and slide it up in the direction of the arrow as illustrated. The cover will slide off.
2. Remove any existing batteries (if necessary) and install two AAA batteries observing the battery polarities as indicated in the base of the battery compartment. Positive (+) goes to positive and negative (-) goes to negative.
3. Refit the cover by aligning it with the base and sliding it back down into position. Stop when it clicks into place.



 **Avoid leaving the remote control and batteries in an excessive heat or humid environment like the kitchen, bathroom, sauna, sunroom or in a closed car.**

Replace only with the same or equivalent type recommended by the battery manufacturer.

Dispose of the used batteries according to the manufacturer's instructions and local environment regulations for your region.

Never throw the batteries into a fire. There may be danger of an explosion.

If the batteries are dead or if you will not be using the remote control for an extended period of time, remove the batteries to avoid damage to the remote control from possible battery leakage.

3. Positioning your projector

Choosing a location

Your room layout or personal preference will dictate which installation location you select. Take into consideration the size and position of your screen, the location of a suitable power outlet, as well as the location and distance between the projector and the rest of your equipment.

The projector is designed to be installed in one of four possible installation locations.

1. Floor Front

Select this location with the projector placed near the floor in front of the screen. This is the most common way to position the projector for quick setup and portability.

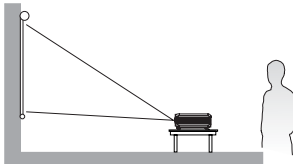

2. Ceiling Front

Select this location with the projector suspended upside-down from the ceiling in front of the screen.

Purchase the BenQ Projector Ceiling Mounting Kit from your dealer to mount your projector on the ceiling.

*Set **Ceiling Front** after you turn the projector on.

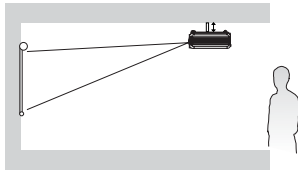

3. Ceiling Rear

Select this location with the projector suspended upside-down from the ceiling behind the screen.

Note that a special rear projection screen and the BenQ Projector Ceiling Mounting Kit are required for this installation location.

*Set **Ceiling Rear** after you turn the projector on.

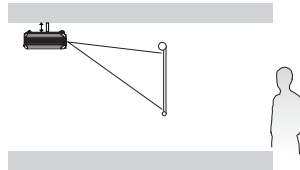

4. Floor Rear

Select this location with the projector placed near the floor behind the screen.

Note that a special rear projection screen is required.

*Set **Floor Rear** after you turn the projector on.

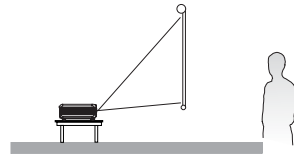

***To set the projector position:**

1. Press **MENU** on the projector or remote control and then press **◀/▶** until the **System Setup** menu is highlighted.
2. Press **▲/▼** to highlight **Projector Position** and press **◀/▶** until the correct position is selected.



Obtaining a preferred projected picture size

The distance from the projector lens to the screen, the zoom setting, and the video format, each factors in the projected picture size.

The projector should always be placed horizontally level (like flat on a table), and positioned directly perpendicular (90° right-angle square) to the horizontal center of the screen. This prevents picture distortion caused by angled projections (or projecting onto angled surfaces).

The modern digital projector does not project directly forward (like older style reel-to-reel film projectors did). Instead, digital projectors are designed to project at a slightly upward angle above the horizontal plane of the projector. This is so that they can be readily placed on a table and will project forward and upwards onto a screen positioned so that the bottom edge of the screen is above the level of the table (and everyone in the room can see the screen).

If the projector is mounted on a ceiling, it must be mounted upside-down so that it projects at a slightly downward angle.

You can see from the diagram on page 20, that this type of projection causes the bottom edge of the projected picture to be vertically offset from the horizontal plane of the projector. When ceiling mounted, this refers to the top edge of the projected picture.

If the projector is positioned further away from the screen, the projected picture size increases, and the vertical offset also increases proportionately.

When determining the position of the screen and projector, you will need to account for both the projected picture size and the vertical offset dimension, which are directly proportional to the projection distance.

BenQ has provided tables of 16:9-aspect-ratio and 4:3-aspect-ratio screen sizes to assist you in determining the ideal location for your projector. There are two dimensions to consider, the perpendicular horizontal distance from the center of the screen (projection distance), and the vertical offset height of the projector from the horizontal edge of the screen (offset).

How to determine the position of the projector for a given screen size

1. Determine the aspect ratio of your screen, 16:9 or 4:3? If you have a 16:9 screen, refer to [Table A](#). If you have a 4:3 screen, refer to [Table B1](#) or [Table B2](#) depending on the projected picture aspect ratio you've got.
2. Select a screen size you desire.
3. Refer to the table and find the closest match to your screen size in the left columns labelled "Screen Dimensions". Using this value, look across this row to the right to find the corresponding average distance from screen value in the column labelled "Average". This is the projection distance.
4. On that same row, look across to the right column and make note of the "Vertical Offset" value. This will determine the final vertical offset placement of the projector in relation to the edge of the screen.

5. The recommended position for the projector is aligned perpendicular to the horizontal center of the screen, at the distance from the screen determined in step 3 above, and offset by the value determined in step 4 above.

For example, if you are using an 120-inch, 4:3-aspect-ratio screen and the projected picture is 15:9, please refer to [Table B2](#). The average projection distance is 4133.7 mm and with a vertical offset of 146 mm.

How to determine the recommended screen size for a given distance

This method can be used for situations where you have purchased this projector and would like to know what screen size will fit in your room.

The maximum screen size is limited by the physical space available in your room.

1. Determine the aspect ratio of the screen you need, 16:9 or 4:3? If you need a 16:9 screen, refer to [Table A](#). If you need a 4:3 screen, refer to [Table B1](#) or [Table B2](#) depending on the projected picture aspect ratio you've got.
2. Measure the distance between the projector and where you want to position the screen. This is the projection distance.
3. Refer to that table and find the closest match to your measurement in the average distance from screen column labelled "[Average](#)". Check that your measured distance is between the min and max distances listed on either side of the average distance value.
4. Using this value, look across that row to the left to find the corresponding "[Screen Dimensions](#)" listed in that row. That is the recommended screen size you can purchase at that projection distance.
5. On that same row, look across to the right column and make note of the "[Vertical Offset](#)" value. This will determine the final placement of the screen in relation to the horizontal plane of the projector.

For example, if you need a 16:9 screen to project a 16:9 picture and your measured projection distance was 4.8 m (4800 mm), please refer to [Table A](#). The closest match in the "[Average](#)" column is 4508 mm. Looking across this row shows that a 120" (3.0 m) screen is required.

Projection dimensions

Refer to "Dimensions" on page 78 for the center of lens dimensions of this projector before calculating the appropriate position.

When the screen aspect ratio is 16:9 and the projected picture is 16:9

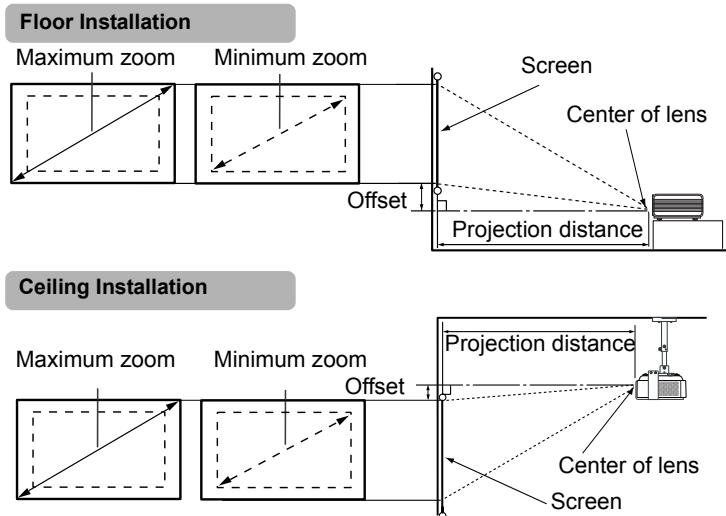
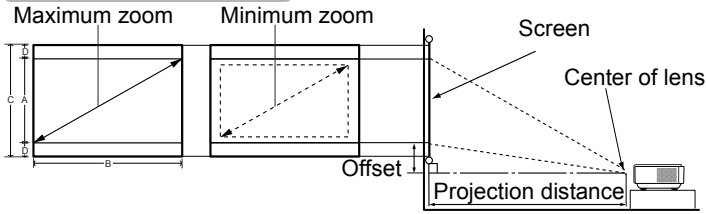

Table A: The screen aspect ratio is 16:9 and the projected picture is 16:9

Screen Dimensions					Distance from Screen in mm			Vertical Offset
Diagonal		Height mm	Width mm		Min length (max. zoom)	Average	Max length (min. zoom)	mm
Feet	Inches							
2.5	30	762	457	610	1043	1127	1210	46
4.2	50	1270	762	1016	1739	1878	2017	76
6.7	80	2032	1219	1626	2783	3005	3228	122
8.3	100	2540	1524	2032	3478	3757	4035	152
10.0	120	3048	1829	2438	4174	4508	4842	183
12.5	150	3810	2286	3048	5217	5635	6052	229
15.0	180	4572	2743	3658	6261	6762	7263	274
16.7	200	5080	3048	4064	6957	7513	8070	305
18.3	220	5588	3353	4470	7652	8264	8877	335
20.0	240	6096	3658	4877	8348	9016	9683	366

When the screen aspect ratio is 4:3 and the projected picture is 16:9 or 15:9

Floor Installation



Ceiling Installation

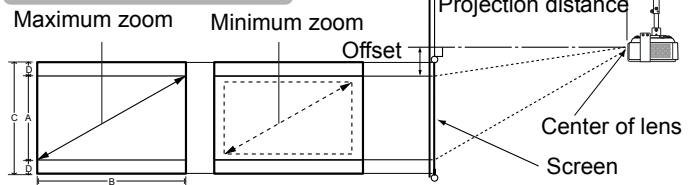



Table B1: The screen aspect ratio is 4:3 and the projected picture is 16:9

Screen Dimensions					Projected picture size		Black bar (D)	Distance from Screen in mm			Vertical Offset
Diagonal			Height	Width	Height	Width		Min (Max zoom)	Average	Max (Min zoom)	
Feet	Inches	mm	C	B	A	B					
2.5	30	762	46	61	34	61	5.7	956.9	1033.4	1110.0	48
4.2	50	1270	76	102	57	102	9.5	1594.8	1722.4	1850.0	80
6.7	80	2032	122	163	91	163	15.2	2551.7	2755.8	2959.9	128
8.3	100	2540	152	203	114	203	19.1	3189.6	3444.7	3699.9	160
10.0	120	3048	183	244	137	244	22.9	3827.5	4133.7	4439.9	192
12.5	150	3810	229	305	171	305	28.6	4784.4	5167.1	5549.9	240
15.0	180	4572	274	366	206	366	34.3	5741.2	6200.5	6659.8	288
16.7	200	5080	305	406	229	406	38.1	6379.2	6889.5	7399.8	320
18.3	220	5588	335	447	251	447	41.9	7017.1	7578.4	8139.8	352
20.0	240	6096	366	488	274	488	45.7	7655.0	8267.4	8879.8	384

Table B2: The screen aspect ratio is 4:3 and the projected picture is 15:9

Screen Dimensions					Projected picture size		Black bar (D)	Distance from Screen in mm			Vertical Offset
Diagonal			Height C	Width B	Height A	Width B		Min (Max zoom)	Average	Max (Min zoom)	
Feet	Inches	mm	cm	cm	cm	cm	cm				mm
2.5	30	762	46	61	37	61	4.6	956.9	1033.4	1110.0	37
4.2	50	1270	76	102	61	102	7.6	1594.8	1722.4	1850.0	61
6.7	80	2032	122	163	98	163	12.2	2551.7	2755.8	2959.9	98
8.3	100	2540	152	203	122	203	15.2	3189.6	3444.7	3699.9	122
10.0	120	3048	183	244	146	244	18.3	3827.5	4133.7	4439.9	146
12.5	150	3810	229	305	183	305	22.9	4784.4	5167.1	5549.9	183
15.0	180	4572	274	366	219	366	27.4	5741.2	6200.5	6659.8	219
16.7	200	5080	305	406	244	406	30.5	6379.2	6889.5	7399.8	244
18.3	220	5588	335	447	268	447	33.5	7017.1	7578.4	8139.8	268
20.0	240	6096	366	488	293	488	36.6	7655.0	8267.4	8879.8	293

 There is 3% tolerance among these numbers in Table A, Table B1, and Table B2 due to optical component variations.

BenQ recommends that if you intend to permanently install the projector, you should physically test the projection size and distance using the actual projector in situ before you permanently install it, so as to make allowance for this projector's optical characteristics. This will help you determine the exact mounting position so that it best suits your installation location.

If you place the projector in a different position (to that recommended), you will have to tilt it down or up, or even turn it slightly left or right to center the picture on the screen. In these situations, some picture distortion will occur. To correct the distortion, see ["Correcting picture distortion" on page 37](#) for details.

4. Connection

When connecting a signal source to the projector, be sure to:

1. Turn all equipment off before making any connections.
2. Use the correct signal cables for each source.
3. Ensure the cables are firmly inserted.

 In the connections shown below, some cables may not be included with the projector (see **"Shipping contents" on page 10**). They are commercially available from electronics stores.

Connecting a computer

The projector provides VGA and DVI input sockets that allow you to connect it to both IBM® compatibles and Macintosh® computers. A Mac adapter (an optional accessory) is needed if you are connecting legacy version Macintosh computers.

To connect the projector to a notebook or desktop computer (either through a VGA cable or VGA to DVI-A cable):

<ul style="list-style-type: none"> • With a VGA cable: <ol style="list-style-type: none"> 1. Take the supplied VGA cable and connect one end to the D-Sub output socket of the computer. 2. Connect the other end of the VGA cable to the D-SUB IN signal input socket on the projector. 	<ul style="list-style-type: none"> • With a VGA to DVI-A cable: <ol style="list-style-type: none"> 1. Take a VGA to DVI-A cable and connect the VGA end to the D-Sub output socket of the computer. 2. Connect the DVI end of the VGA to DVI-A cable to the DVI-I signal input socket on the projector.
<ol style="list-style-type: none"> 3. If you wish to use the remote paging function (see "Remote paging operations" on page 56), take a USB cable and connect the larger end to the USB port of the computer, and the smaller end to the USB socket on the projector. 	

The final connection path should be like that shown in the following diagram:

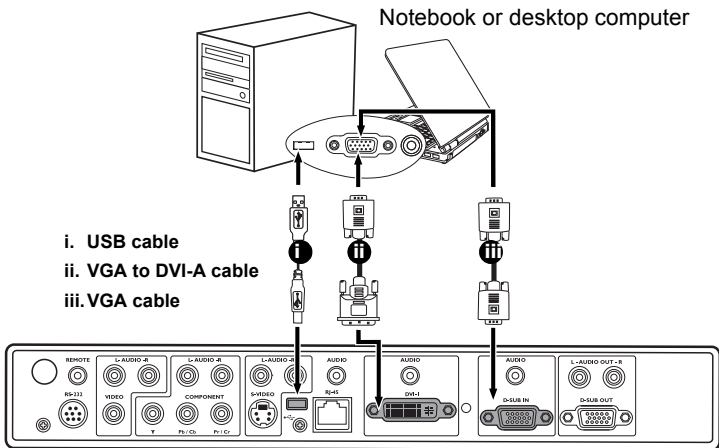

 Many notebooks do not turn on their external video ports when connected to a projector. Usually a key combo like FN + F3 or CRT/LCD key turns the external display on/off. Locate a function key labeled CRT/LCD or a function key with a monitor symbol on the notebook. Press FN and the labeled function key simultaneously. Refer to your notebook's documentation to find your notebook's key combination.

Connecting a monitor

If you want to view your presentation close-up on a monitor as well as on the screen, you can connect the projector to an external monitor by following the instructions below.

To connect the projector to a monitor (either through a VGA cable or VGA to DVI-A cable):

<ul style="list-style-type: none"> With a VGA cable: 	<ul style="list-style-type: none"> With a VGA to DVI-A cable: <p>Note: Your monitor must be equipped with a DVI input socket.</p>
<ol style="list-style-type: none"> Connect the projector to a computer as described in "Connecting a computer" on page 23. The D-SUB OUT output only works when an appropriate D-Sub input is made to the projector. Be sure the projector is connecting with the computer using the D-SUB IN socket, not the DVI-I socket. 	
<ol style="list-style-type: none"> Take a suitable VGA cable (only one supplied) and connect one end of the cable to the D-Sub input socket of the video monitor. Connect the other end of the cable to the D-SUB OUT socket on the projector. 	<ol style="list-style-type: none"> Take a VGA to DVI-A cable and connect the DVI end of the cable to the DVI input socket of the video monitor. Connect the VGA end of the cable to the D-SUB OUT socket on the projector.

The final connection path should be like that shown in the following diagram:

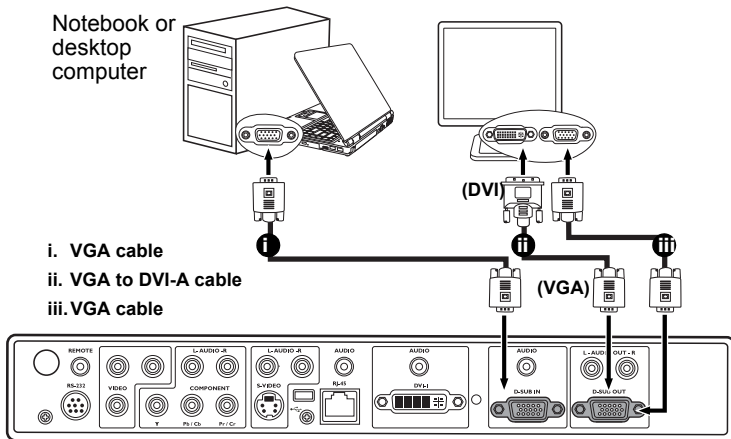

Connecting Video source devices

This section describes how to connect the projector to Video source devices using video cables. Video cable connections are recommended for Video presentations.

You can connect your projector to various Video source devices that provide any one of the following output sockets:

- DVI
- Component Video
- S-Video
- Video (composite)

The method you choose will most likely depend upon the availability of matching terminals on both the projector and the Video source device as described below:

Best video quality

The best available video connection method is DVI. If your source device is equipped with a DVI socket, based on the type of DVI connector you have, you can enjoy digital or high-end analog video quality.

See ["Connecting a DVI source device" on page 26](#) for how to connect the projector to a DVI source device and other details.

If no DVI source is available, the next best video signal is Component Video (not to be confused with composite Video). Digital TV tuners and DVD players output Component Video natively, so if available on your devices, they should be your connection method of choice in preference to S-Video or (composite) Video.

See ["Connecting a Component Video source device" on page 27](#) for how to connect the projector to a component video device.

Better video quality

The S-Video method provides a better quality analog video than standard composite Video. If you have both composite Video and S-Video output terminals on your Video source device, you should select to use the S-Video option.

See ["Connecting an S-Video or a composite Video source device" on page 28](#) for how to connect the projector to an S-Video device.

Least video quality

Composite Video is an analog video and will result in a perfectly acceptable, but less than optimal result from your projector, being the least video quality of the available methods described here.

See ["Connecting an S-Video or a composite Video source device" on page 28](#) for how to connect the projector to a composite Video device.

Connecting a DVI source device

The projector provides a DVI-I input socket that allows you to connect it to a DVI source device like a DVD player, or a VGA output device like a notebook or desktop computer.

There are three types of DVI connectors: DVI-A, DVI-D, and DVI-I. The DVI-I socket is an integrated connector which supports both formats: DVI-A, and DVI-D.

DVI-A format is used to carry a DVI signal to an analog (VGA) display, or vice-versa. Although some signal quality is lost from the signal conversion, it still transmits higher picture quality than a standard VGA connection.

DVI-D format is used to directly carry a digital signal to a digital display without signal conversion. The pure digital connection provides faster and higher picture quality than an analog connection, due to the nature of the digital format.

DVI-A and DVI-D formats are non-interchangeable. You cannot connect a DVI-A format connector to DVI-D equipment and visa-versa. Make sure you know which kind of format your equipment is fitted with before you purchase any cables. Or you can purchase a DVI-I cable which will be more useful in any type of DVI connection situation.

Examine your source device to determine if it has an unused DVI or VGA (D-Sub) output socket available:

- If so, you can continue with this procedure.
- If not, you will need to reassess which method you can use to connect to the device.

To connect the projector to a DVI source device or a computer:

 For information on connecting a DVI source device to a computer through a VGA to DVI-A cable, see ["Connecting a computer" on page 23](#).

1. Take the DVI (DVI-D or DVI-I) cable and connect one end to the DVI output socket of the DVI source device.
2. Connect the other end of the cable to the **DVI-I** signal input socket on the projector. The final connection path should be like that shown in the following diagram:

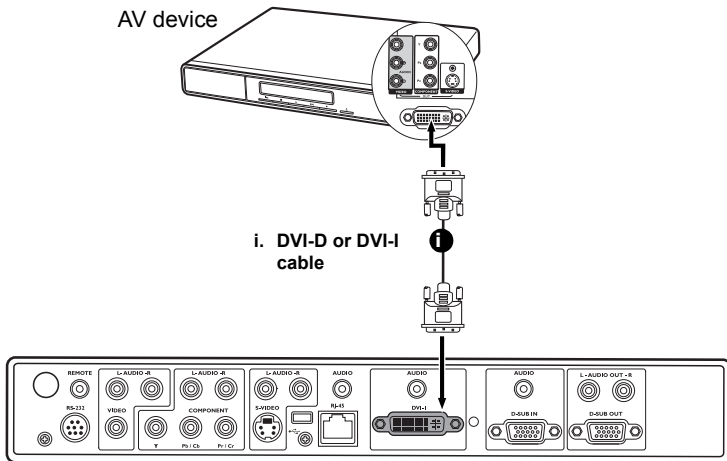

Connecting a Component Video source device

Examine your Video source device to determine if it has a set of unused Component Video output sockets available:

- If so, you can continue with this procedure.
- If not, you will need to reassess which method you can use to connect to the device.

To connect the projector to a Component Video source device through a Component Video cable:

1. Take a Component Video cable and connect one end to the Component Video output sockets of the Video source device. Match the color of the plugs to the color of the sockets; green to green, blue to blue; and red to red.
2. Connect the other end of the Component Video cable to the **COMPONENT** sockets (Y, Pb/Cb, Pr/Cr) on the projector. Match the color of the plugs to the color of the sockets; green to green, blue to blue; and red to red.

The final connection path should be like that shown in the following diagram:

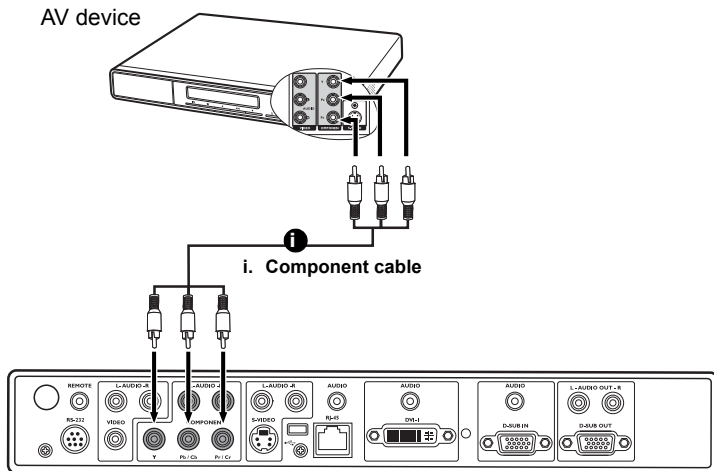

- ☞ • **Component Video is the only video input that delivers native 16:9 aspect ratio picture.**
- **If the selected video picture is not displayed after the projector is turned on and the correct video source has been selected, check that the Video source device is turned on and operating correctly. Also check that the signal cables have been connected correctly.**

Connecting an S-Video or a composite Video source device

Examine your Video source device to determine if it has an unused S-Video or Video output socket available:

- If it has both sockets, use the S-Video output socket for connection as the S-Video terminal provides better picture quality than the Video terminal. See "[Connecting Video source devices](#)" on page 25 for details.
- If it has either of the output socket, you can also continue with this procedure.
- If not, you will need to reassess which method you can use to connect to the device.

 **If you have already made a Component Video connection between the projector and the video source device, you need not connect to this device again using an S-Video or composite Video connection as this makes an unnecessary second connection of poorer picture quality. You need only connect using a composite Video connection if both Component Video and S-Video are not supplied on the video source device (for example, with some analog video cameras).**

To connect the projector to an S-Video/Video source device:

1. Take an S-Video cable/Video cable and connect one end to the S-Video/Video output socket of the Video source device.
2. Connect the other end of the S-Video cable/Video cable to the **S-VIDEO/VIDEO** socket on the projector.

The final connection path should be like that shown in the following diagram:

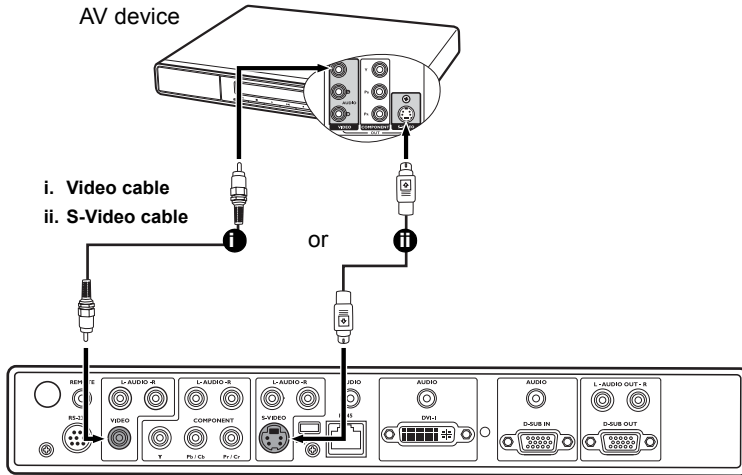

 **If the selected video picture is not displayed after the projector is turned on and the correct video source has been selected, check that the Video source device is turned on and operating correctly. Also check that the signal cables have been connected correctly.**

Connecting Audio device

The projector has built-in speakers which are designed to provide basic audio functionality accompanying data presentations for business purposes only. It is not designed for, nor intended for audio reproduction use as might be expected in home theater or home cinema applications.

If you wish, you can make use of the projector speakers in your presentations, and also connect separate amplified speakers to the **AUDIO OUT (L/R)** sockets of the projector.

If you have a separate sound system, you will most likely want to connect the audio output of your Video source device to that sound system, instead of to the projector.

The audio connections illustrated in the following diagram is provided for informational purposes only. You need not connect audio to the projector if there is an alternate sound system available, or if audio is not required.

1. If you wish to make use of the projector speakers in your presentations, take a suitable audio cable and connect one end of the cable to the audio output socket on the computer or video device, and the other end to the audio socket(s) corresponding to the connected signal socket of the projector.

Which audio cable you use depends on what device you have.

If you have a computer or DVI device connected to the **D-SUB IN, DVI-I or RJ-45** socket, use a stereo mini-jack cable.

If you have a video device connected to the **COMPONENT, VIDEO, or S-VIDEO** socket(s), use a RCA-style cable.

2. If you wish to connect separate amplified speakers, you can use another suitable audio cable and connect the end with 2 RCA type connectors to the **AUDIO OUT (L/R)** sockets of the projector, and the other end to your external speakers (not supplied). Match the color of the plugs to the color of the sockets; white to white, and red to red.

 **The AUDIO OUT (L/R) outputs work when any of audio input is made to the projector.**

Once connected, the audio can be controlled by the remote control (**MUTE, AUDIO**) or projector On-Screen Display (OSD) menus. See ["Adjusting the sound" on page 55](#) for details.

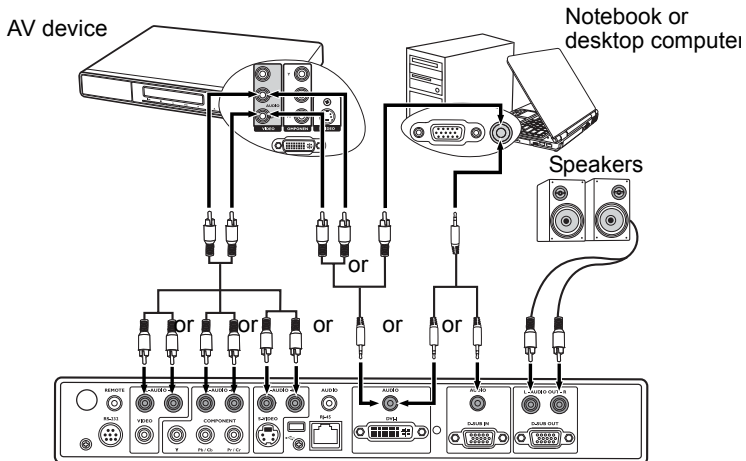

5. Operation

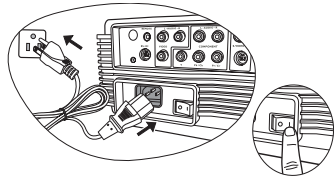

Starting up the projector

1. Plug the power cord into the projector and into a wall socket. Turn on the wall socket switch (where fitted).
2. Press the main power switch to the I position.
Check that the **Power indicator** on the projector lights orange after power has been applied.

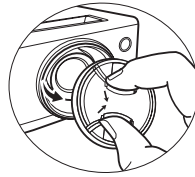

3. Remove the lens cap.
If it is left on, it could become deformed due to the heat produced by the projection lamp.



4. Press and hold (for 2 seconds)  on the projector or remote control to start the projector.
The **Power indicator light** flashes green and stays green when the projector is on.
The start up procedure takes about 30 seconds after pressing . In the later stage of start up, a default BenQ logo is projected.
(If necessary) Rotate the focus ring to adjust the picture clearness.

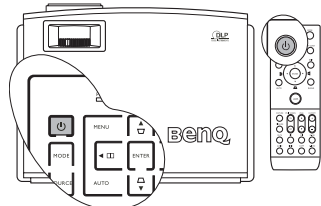

5. If you are prompted for a password, press the arrow keys to enter a six digit password.
6. Switch all of the connected equipment on.
The projector will start to search for input sources. The current input source being scanned displays in the lower right corner of the screen. If the projector doesn't detect a valid signal, the searching message will continue displaying until an input source signal is found.
You can also press **SOURCE** on the projector or remote control to display the signal selection bar and switch between different signals. See "[Switching input source](#)" on page 35 for details.

 **If the projector is still hot from previous activity, it will run the cooling fans for approximately 90 seconds before energizing the lamp.**

 **See "[Utilizing the password function](#)" on page 32 for details.**

 **If the frequency/resolution of the input source exceeds the projector's operating range, you will see the message 'Out of Range' displayed on a blank screen. Please change to an input source which is compatible with the projector's resolution or set the input source to a lower setting. See "[Timing chart](#)" on page 77 for details.**

Using the menus

The projector is equipped with multilingual On-Screen Display (OSD) menus for making various adjustments and settings.

Below is the overview of the OSD menu.



To use the OSD menus, please set the OSD menu to your familiar language first.

1. Press **MENU** on the projector or remote control to turn the OSD menu on.



3. Press **▼** to highlight **Language** and press **◀/▶** to select a preferred language.



2. Use **◀/▶** to highlight the **System Setup** menu.



4. Press **MENU** once or **EXIT** twice* on the projector or remote control to leave and save the settings.

*The first press leads you back to the main menu and the second press closes the OSD menu.

Securing the projector

Using a security cable lock

The projector has to be installed in a safe place to prevent stealing. If not, purchase a lock, like Kensington lock, to secure the projector. You can locate a Kensington lock slot on the rear side of the projector. See item 26 on page 11 for details.

A Kensington security cable lock is usually the combination of key(s) and lock. Refer to the lock's documentation about how to use it.

Utilizing the password function

For security purposes and to help prevent unauthorized use, the projector includes an option for setting up password security. The password can be set through the On-Screen Display (OSD) menu. Once the password is set and this function is selected, the projector is password-protected. Users who do not know the correct password can not use the projector.

⚠ You will be inconvenienced if you activate the password functionality and subsequently forget the password. Print out this manual (if necessary) and write the password you used in this manual, and keep the manual in a safe place for later recall.

Setting a password

👉 Once a password has been set and activated, the projector cannot be used unless the correct password is entered every time the projector is started.

1. Press **MENU** on the projector or remote control and then press **◀/▶** until the **Advanced Setup** menu is highlighted.
2. Press **▼** to highlight **Password** and press **ENTER**. The **Password** page displays.
3. Highlight **Password** and press **◀/▶** to select **On**. The **Input Password** page displays.
4. As the picture indicates, the four arrow keys (**▲**, **▶**, **▼**, **◀**) respectively represent 4 digits (1, 2, 3, 4). According to the password you desire to set, press the arrow keys on the remote control or projector to enter six digits for the password. Once the password is set, the OSD menu returns to the **Password** page.

IMPORTANT: The digits being input will display as asterisks on-screen. Write your selected password down here in this manual in advance or right after the password is entered so that it is available to you should you ever forget it.

Password: _____
Keep this manual in a safe place.

5. To leave the OSD menu, press **MENU**.



If you forget the password

If the password function is activated, you will be asked to enter the six-digit password every time you turn on the projector. If you enter the wrong password, the password error message as pictured to the right displays lasting for three seconds, and the **Input Password** page follows. You can retry by entering another six-digit password, or if you did not record the password in this manual, and you absolutely do not remember it, you can use the password recall procedure. See "[Entering the password recall procedure](#)" on page 33 for details.

If you enter an incorrect password 5 times in succession, the projector will automatically shut down in a short time.

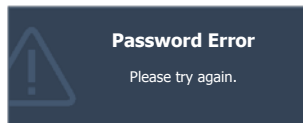

Entering the password recall procedure

1. Press and hold **AUTO** on the projector or remote control for 3 seconds. The projector will display a coded number on the screen.
2. Write down the number and turn off your projector.
3. Seek help from the local BenQ service center to decode the number. You may be required to provide proof of purchase documentation to verify that you are an authorized user of the projector.

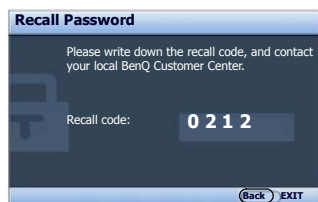

Changing the password

1. Press **MENU** on the projector or remote control and then press ◀/▶ until the **Advanced Setup** menu is highlighted.
2. Press ▲/▼ to highlight **Password** and press **ENTER**. The **Password** page displays.
3. Highlight **Change Password** and press **ENTER**. The **Input Current Password** page displays.
4. Enter the old password.
 - If the password is correct, the message '**Input New Password**' displays.
 - If the password is incorrect, the password error message displays lasting for three seconds, and the message '**Input Current Password**' displays for your retry. You can either press **MENU** to cancel the change or try another password.
5. Enter a new password.

IMPORTANT: The digits being input will display as asterisks on-screen. Write your selected password down here in this manual in advance or right after the password is entered so that it is available to you should you ever forget it.

Password: _ _ _ _ _
Keep this manual in a safe place.

6. Confirm the new password by re-entering the new password.

7. You have successfully assigned a new password to the projector. Remember to enter the new password next time the projector is started.
8. To leave the OSD menu, press **MENU**.



Disabling the password function

To disable password protection, go back to the **Advanced Setup > Password > Password** menu.

Highlight **Password** and select **Off** by pressing ◀/▶. The message '**Input Password**' displays. Enter the current password.

- If the password is correct, the OSD menu returns to the **Password** page with '**Off**' shown in the row of Password. You will not have to enter the password next time when turning on the projector.
- If the password is incorrect, the password error message displays lasting for three seconds, and the message '**Input Password**' displays for your retry. You can either press **MENU** to cancel the change or try another password.

Note that though the password function is disabled, you need to keep the old password in hand should you ever need to re-activate the password function by entering the old password.



Switching input source

The projector can be connected to multiple devices at the same time. When starting up, the projector automatically search for the available signals.

Be sure the **Auto Source Search** function in the **System Setup** menu is **On** (which is the default of this projector) if you want the projector to automatically search for the signals.

You can also manually cycle through the available input sources.

1. Press **SOURCE** on the projector or remote control. The source selection bar displays. (Pressing **ENTER** in the **System Setup** > **Input Source** menu performs the same function.)
2. Press **▲/▼** repeatedly until your desired signal is selected and press **ENTER**.
Once detected, the selected source information will display in the corner of the screen for 3 seconds. If there is multiple equipment connected to the projector, you can press the key again to search for other signals.

The projector feature **Split Screen** and **PIP** functions which allow 2 different signals to be displayed at the same time. See "[Displaying more than one picture source simultaneously](#)" on page 51 for details.

The brightness level of the projected picture will change accordingly when you switch between different input sources. Data (graphic) "PC" presentations using mostly static pictures are generally brighter than "Video" using mostly moving pictures (movies).

The input source type effects the options available for the **Picture Mode**. See "[Selecting a picture mode](#)" on page 42 for details.

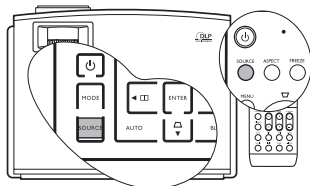

Select **RJ-45** only when the optional **Signal Shuttle** module is connected to the projector **RJ-45** input socket.

Adjusting the projected picture

Adjusting the projection angle

The projector is equipped with 2 quick-release adjuster feet. These adjusters change the picture height and projection angle.

To adjust the projector, slightly lift the front of the projector and press and hold the quick-release buttons on the both sides near bottom until the picture is positioned where you want it.

To retract the foot, hold up the front of the projector while pressing the quick-release buttons, then slowly lower the projector.

If the projector is not placed on a flat surface or the screen and the projector are not perpendicular to each other, the projected picture becomes trapezoidal. To correct this situation, see "[Correcting picture distortion](#)" on [page 37](#) for details.

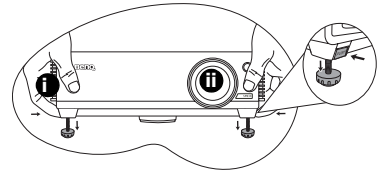

-  i. Be aware of the vent where hot air comes from.
- ii. Do not look into the lens while the lamp is on. The strong light from the lamp may cause damage to your eyes.

Auto-adjusting the picture

In some cases, you may need to optimize the picture quality. To do this, press **AUTO** on the projector or remote control. Within 3 seconds, the built-in Intelligent Auto Adjustment function will re-adjust the values of Frequency and Clock to provide the best picture quality.

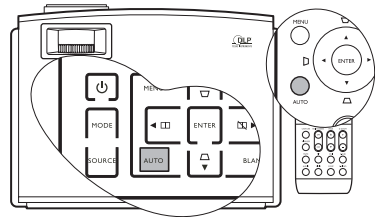

Fine-tuning the picture size and clarity

1. Adjust the projected picture to the size that you need using the zoom ring.

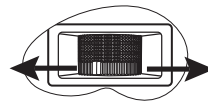

2. Then sharpen the picture by rotating the focus ring.

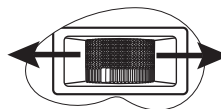

Correcting picture distortion

Correcting two-dimensional keystone

Keystoning occurs when the projector is not perpendicular to the screen and is where the projected picture displays visible as a trapezoid shape like either of the following:

- Two parallel sides (left and right, or top and bottom) but is noticeably wider on either side.
- No parallel sides.

To correct the picture's shape, you can perform the following steps.

1. Adjust the projection angle. Move the projector to be in front of the center of the screen with the base of the lens level with the top or bottom edge of the screen.
2. If the picture is still distorted, or the projector is unable to be positioned as described above, you will need to manually correct the picture.

- **Using the remote control or projector**

- i. Press one of the Keystone/Arrow keys (◁/▲, ▷/▲, ▷/▼, ▷/► on the remote control, or ◁/▲, ▷/▼ on the projector) to display the **Keystone** page.
- ii. See step **iv** below for further operation.

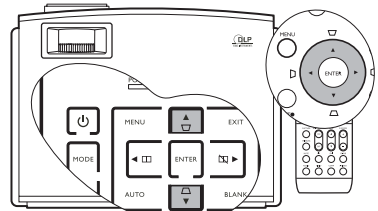

- **Using the OSD menu**

- i. Press **MENU** and then press ◀/▶ until the **Display** menu is highlighted.
- ii. Press ▼ to highlight **Keystone** and press **ENTER**. The **Keystone** page displays.
- iii. Highlight **2D Keystone** and press **ENTER**. The keystone correction page displays.



- iv. Press the key whose keystone icon is similar to the shape of the projected picture. Continue pressing the same key or press the other keys until you are satisfied with the shape.

The values on the lower portion of the page change while pressing. When the values reach their maximum or minimum with repeated key presses, the picture's shape will stop changing. You will not be able to change the picture further in that direction.



Correcting pincushion distortion and barrel distortion

Your projected picture may suffer from pincushion or barrel distortions due to the curved projection surface.

- **Pincushion distortion**

The horizontal and vertical lines that do not go through the center of the picture bend inwards toward the center of the picture. The distortion is most noticeable at the edges of the picture.

- **Barrel distortion**

The horizontal and vertical lines that do not go through the center of the picture bend outwards toward the center of the picture. The distortion is most noticeable at the edges of the picture.

To correct the image's shape, you can perform the following steps.

1. Press **MENU** and then press **◀/▶** until the **Display** menu is highlighted.
2. Press **▼** to highlight **Keystone** and press **ENTER**. The **Keystone** page displays.
3. Press **▼** to highlight **Pincushion Correction** and press **◀/▶** repeatedly to adjust the image until you are satisfied with the shape.



Two parallel sides



No parallel sides



Pincushion/Barrel correction

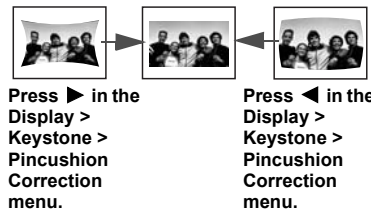

Selecting the aspect ratio

The 'aspect ratio' is the ratio of the picture width to the picture height. Most analog TV and computers are in 4:3 ratio, and digital TV and DVDs are usually in 16:9 ratio.

With the advent of digital signal processing, digital display devices like this projector can dynamically stretch and scale the picture output to a different aspect than that of the picture input source.

To change the projected picture ratio (no matter what aspect the source is):

- **Using the remote control**
 1. Press **ASPECT** to show the current setting.
 2. Press **ASPECT** repeatedly to select an aspect ratio to suit the format of the video signal and your display requirements.
- **Using the OSD menu**
 1. Press **MENU** and then press ◀/▶ until the **Display** menu is highlighted.
 2. Press ▼ to highlight **Aspect Ratio**.
 3. Press ◀/▶ to select an aspect ratio to suit the format of the video signal and your display requirements.

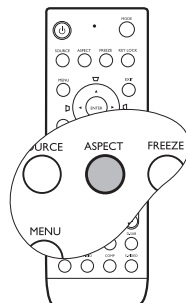

Shifting the picture around the black areas

If there are unused resolutions along the top and bottom sides, you can shift the pictures vertically until it reaches the top or bottom of the unused areas.

To shift the picture:

1. In the **Display** menu, press ▲ or ▼ to highlight **Digital Screen Shift**.
2. Press ◀ or ▶ to adjust the vertical position of the projected areas.

About the aspect ratio

1. **4:3:** Scales a picture so that it is displayed in the center of the screen with a 4:3 aspect ratio. This is most suitable for 4:3 pictures like computer monitors, standard definition TV and 4:3 aspect DVD movies, as it displays them without aspect alteration.

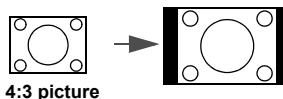

4:3 picture

2. **Anamorphic:** Scales a picture so that it is displayed in the center of the screen using 1280 x 720 pixels. This may alter the projected aspect, depending upon the original aspect of the source image. Anamorphic is most suitable for images which are already in a 16:9 aspect, like high definition TV, as it displays them without aspect alteration.
3. **Fill:** Resizes the picture to the full projection area. 1280 x 768 pixel is used without maintaining the original aspect ratio. This is most suitable for 15:9 pictures.
4. **Letter Box:** Scales a picture to fit the projector's native resolution in its horizontal width and resize the picture's height to the 3/4 of the projection width. 1280 x 960 pixels are used in this projection. This may produce a picture greater in height than can be displayed, so part of the picture is lost (not displayed) along the top and bottom edges of the projection. This is suitable for the display of movies which are presented in letter box format (with black bars on the top and bottom).
5. **Wide:** Stretches the picture horizontally in a non-linear manner, that is, the edges of the picture are stretched more than the center of the picture to prevent distortion of the central part of the picture. This is suitable for occasions where you want to stretch the width of a 4:3 aspect picture to the width of a 16:9 aspect screen. It does not alter the height. Some widescreen movies have been produced with their width squashed down to the width of a 4:3 aspect, and are best viewed when restretched back to their original width using this setting.
6. **Real:** For input sources with lower resolutions than 1280 x 768, the projected picture will display smaller than if resized to full screen. If the input source is with higher resolution than 1280 x 768, the picture will be resized proportionally until it fits the width or height of the projection.

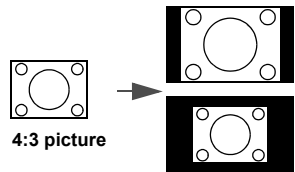
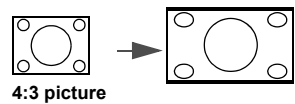
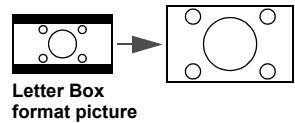
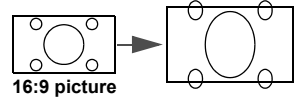
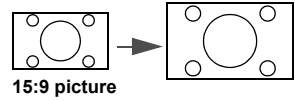
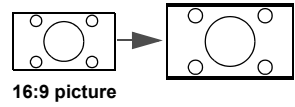

 **OSD menus can be displayed on those unused black areas.**

Magnifying and Searching for details on the projected picture

If you need to find the details on the projected picture, magnify the picture. The picture can be enlarged up to 300% than the original picture size with 50% increments. Use the direction arrow keys for navigating the picture.

• Using the remote control

1. Press **D. ZOOM +** to display the Zoom bar. The center of the picture will be magnified when the key is pressed again. Press the key repeatedly until the picture size is suitable for your need.
2. Use the directional arrow keys (**▲**, **▼**, **◀**, **▶**) on the projector or remote control to navigate the picture.

 **The picture can only be navigated after the picture is magnified. You can further magnified the picture while searching for details.**

3. To reduce size of the picture, press **D. ZOOM -**. When the key is pressed again, the picture is further reduced until it is restored to the original size.

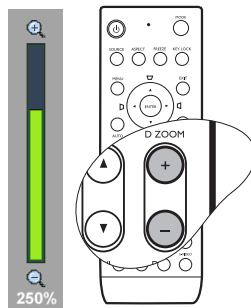

• Using the OSD menu

1. Press **MENU** and then press **◀/▶** until the **Display** menu is highlighted.
2. Press **▼** to highlight **Digital Zoom**.
3. Press **▶** to magnify the picture to a desired size.
4. Press **▼** to highlight **Pan** and press **ENTER** to display the **Pan** page.

 **The Pan sub-menu is only available when the picture is magnified.**

5. Use the directional arrow keys (**▲**, **▼**, **◀**, **▶**) on the projector or remote control to navigate the picture.
6. To reduce size of the picture, press **EXIT** or press **MENU** to go back to the **Display** menu, highlight **Digital Zoom**, and press **◀** repeatedly until it is restored to the original size.



Selecting a picture mode

The projector is preset with several pre-defined picture modes so that you can choose one to suit your operating environment and input source picture type.

The picture modes available for different types of signals are listed below.

1. **Dynamic** mode: Maximizes the brightness of the projected picture. This mode is suitable for environments where extra-high brightness is required, such as using the projector in well lit rooms.
2. **Cinema** mode: Is suitable for enjoying DVD movies best viewed in a blackened (little light) home cinema or lounge room environment.
3. **Blackboard** mode: Is designed for educational use. Images are allowed to be projected on a dark background, such as a blackboard instead of a normal screen. It is most suitable for a well lit environment with a dark background for projection.
4. **User 1/User 2/User 3** mode: Recalls the settings customized based on the current available picture modes. See "Setting the User 1/User 2/User 3 mode" on page 43 for details.
5. **Presentation** mode (only for graphic input sources*): Is designed for presentations. The brightness is emphasized in this mode to match PC and notebook coloring.
6. **sRGB** mode (only for graphic input sources*): Maximizes the purity of RGB colors to provide true-to-life pictures regardless of brightness setting. It is most suitable for viewing photos taken with an sRGB compatible and properly calibrated camera, and for viewing PC graphic and drawing applications such as AutoCAD.
7. **Standard** mode (only for Video input sources**): Is appropriate for viewing colorful movies, video clips from digital cameras or DVs.

*Graphic input sources: Analog RGB, DVI-A, DVI-D, RJ-45

**Video input source: Component, S-Video, Video

To select a picture mode that suits your need:

- **Using the remote control**

1. Press **MODE** on the remote control or projector repeatedly until your desired mode is selected.

- **Using the OSD menu**

1. Press **MENU** and then press **◀/▶** until the **Picture -- Basic** menu is highlighted.
2. Press **▼** to highlight **Picture Mode**.
3. Press **◀/▶** until your desired mode is selected.

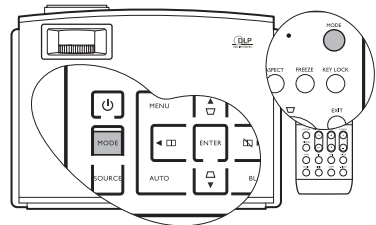

Fine-tuning the selected picture mode

The pre-defined picture mode settings can be altered via the available items shown in the **Picture -- Basic** and **Picture -- Advanced** menus.

To fine-tune the picture mode:

1. Press **MENU** and then press **◀/▶** until the **Picture -- Basic** or **Picture -- Advanced** menu is highlighted.
2. Press **▼** to highlight the item you want to adjust (from among **Brightness, Contrast, Color, Tint, Sharpness, Color Temperature, Clarity Control, Gamma Selection, Color Management**) and press **◀/▶** to set your desired value. Your selection is automatically stored in the projector and associated with that input source.
See "[Fine-tuning the picture quality](#)" on page 45 and "[Advanced picture quality controls](#)" on page 46 for details.

Each time you change the picture mode, the projector also changes the setting to the one which was last set for that particular picture mode on that particular input. If you change the input source, the most recently used picture mode and settings for that input and resolution will be restored.

Setting the User 1/User 2/User 3 mode

There are three user-definable modes if the current available picture modes are not suitable for your need. You can use one of the picture modes (except the selected User mode) as a starting point and customize the settings.

1. In the **Picture -- Basic** menu, highlight **Picture Mode** and press **◀/▶** to select **User 1, User 2, or User 3** mode.
2. Press **▼** to highlight **Load Settings From**.

 **This function is only available when User 1, User 2, or User 3 mode is selected up in the Picture Mode sub-menu item.**

3. Press **ENTER** to display the **Load Settings From** page.
4. Press **▼** to highlight a picture mode that is closest to your need and press **ENTER** and **EXIT**.
5. Press **▼** to select a sub-menu item to be changed and adjust the value with **◀/▶**. See "[Fine-tuning the picture quality](#)" on page 45 for details.
6. When all settings have been done, press **MENU** to save and leave the settings.



Renaming user modes

You can change **User 1**, **User 2**, and **User 3** to the names easy to be identified or understood by the users of this projector. The new name can be up to 12 characters including English letters (A-Z, a-z), digits (0-9), and space (_).

To rename user modes:

1. In the **Picture -- Basic** menu, highlight **Rename User Mode** and press **ENTER** to display the **Rename User Mode** page.
2. Press **▲/▼** to highlight the item you want to rename and press **ENTER**. The first letter will be highlighted by a white box.
3. Press **▲/▼** to select the first character.
4. Press **▶** to move along until the new name is set and press **ENTER** to confirm.
5. Repeat steps 2-4 if you want to change the other names.

Resetting the picture mode

All of the adjustments you've done in the **Picture -- Basic** and **Picture -- Advanced** menus can be returned to the factory preset values with a key press on the highlight of **Reset**.

To reset the picture mode to the preset factory values:

1. In the **Picture -- Basic** menu, highlight **Picture Mode** and press **◀/▶** to select the picture mode (including **User 1**, **User 2**, or **User 3**) you want to reset.
2. Press **▼** to highlight **Reset Picture Settings** and press **ENTER**. The confirmation message displays.
3. Press **◀/▶** to highlight **Reset** and press **ENTER**. The picture mode will return to the factory preset settings.
4. Repeat steps 1-3 if you want to reset other picture modes.

 **Do not to be confused with the Reset Picture Settings function here with the Reset All Settings in the Advanced Setup menu. The Reset All Settings function returns most of the settings to the factory preset values system wide. See "Reset All Settings" on page 65 for details.**

Fine-tuning the picture quality

No matter what picture mode you have selected, you are able to fine-tune those settings to fit every presentation purpose. Those adjustments will be saved to the preset mode you are at when you exit the OSD menu.

Adjusting Brightness

Highlight **Brightness** in the **Picture -- Basic** menu and adjust the values by pressing ◀/▶ on the projector or remote control.



The higher the value, the brighter the picture. And lower the setting, darker the picture. Adjust this control so the black areas of the picture appear just as black and that detail in the dark areas is visible.

Adjusting Contrast

Highlight **Contrast** in the **Picture -- Basic** menu and adjust the values by pressing ◀/▶ on the projector or remote control.



The higher the value, the greater the contrast. Use this to set the peak white level after you have previously adjusted the **Brightness** setting to suit your selected input and viewing environment.

Adjusting Color

Highlight **Color** in the **Picture -- Basic** menu and adjust the values by pressing ◀/▶ on the projector or remote control.

Lower setting produces less saturated colors; setting to the minimum value makes the image black and white. If the setting is too high, colors on the image will be overpowering, which makes the image unrealistic.

Adjusting Tint

Highlight **Tint** and adjust the values by pressing ◀/▶ on the projector or remote control.

The higher the value, the more reddish the picture becomes. The lower the value, the more greenish the picture becomes.

Adjusting Sharpness

Highlight **Sharpness** and adjust the values by pressing ◀/▶ on the projector or remote control.



The higher the value, the sharper the picture becomes. The lower the value, the softer the picture becomes.

Advanced picture quality controls

There are more advanced functions in the **Picture -- Advanced** menu to be adjusted to your preference. To save the settings, just press **MENU** to leave the OSD menu.

Setting Black Level

Highlight **Black Level** and press ◀/▶ on the projector or remote control to select **0 IRE** or **7.5 IRE**.

The grayscale video signal is measured in IRE units. In some areas which use NTSC TV standard, the grayscale is measured from 7.5 IRE (black) to 100 IRE (white); however, in other areas which use PAL equipment or Japanese NTSC standard, the grayscale is measured from 0 IRE (black) to 100 IRE (white). We suggest that you check the input source if it is with 0 IRE or 7.5 IRE, then select accordingly.

Controlling image clarity

You may have static or noisy projected pictures.

To achieve better picture clarity:

1. Highlight **Clarity Control** and press **ENTER** on the projector or remote control to display the **Clarity Control** page.
2. Press ▲/▼ to select the item you want to adjust and press ◀/▶ to set the desired value.
 - **Noise Reduction:** Reduces electrical image noise caused by different media players. The higher the setting, the less the noise.
 - **Detail Enhancement:** Sharpens the image. The higher the setting, the more details the image reveals.
 - **LTI** (Luminance Transmission Improvement): Enhances picture brightness. The higher the setting, the more distinct the effect.
 - **CTI** (Chroma Transmission Improvement): Reduces color smear. The higher the setting, the more distinct the effect.



Selecting a color temperature*

Highlight **Color Temperature** and select a preferred setting by pressing ◀/▶ on the projector or remote control.

There are several color temperature settings available.

1. **Lamp Native:** With the lamp's original color temperature and higher brightness. This setting is suitable for environments where high brightness is required, such as projecting pictures in well lit rooms.
2. **Warm:** Makes pictures appear reddish white.
3. **Normal:** Maintains normal colorings for white.
4. **Cool:** Makes pictures appear bluish white.
5. **User 1/User 2/User 3:** Recalls the settings customized in the **Color Temp User_ Fine Tuning** menu. See "[Setting a preferred color temperature](#)" on page 47 for details.

Setting a preferred color temperature

To set a preferred color temperature:

1. Highlight **Color Temperature** and select **User 1**, **User 2**, or **User 3** by pressing ◀/▶ on the projector or remote control.
2. Press ▼ to highlight **Color Temp User_ Fine Tuning** and press ENTER. The **Color Temp User_ Fine Tuning** page displays.



The menu name 'User_' corresponds with the setting selected in **Color Temperature**.

3. Press ▲/▼ to highlight the item you want to change and adjust the values by pressing ◀/▶.
 - **Red Gain/Green Gain/Blue Gain:** Adjusts the contrast levels of Red, Green, and Blue.
 - **Red Offset/Green Offset/Blue Offset:** Adjusts the brightness levels of Red, Green, and Blue.
4. To save and leave the settings, press **MENU** once or **EXIT** twice.



***About color temperatures:**
There are many different shades that are considered to be "white" for various purposes. One of the common methods of representing white color is known as the "color temperature". A white color with a low color temperature appears to be reddish white. A white color with a high color temperature appears to have more blue in it.

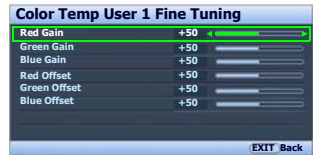

Color Management

The **Color Management** provides six sets (RGBCMY) of colors to be adjusted to favorite colors. When you select each color, you can independently adjust its color range and saturation according to your preference.

To adjust and store the settings:

1. In the **Picture -- Advanced** menu, highlight **Color Management** and press **ENTER**. The **Color Management** page displays.
2. Highlight **Primary Color** and press **◀/▶** to select a color from among **Red**, **Yellow**, **Green**, **Cyan**, **Blue**, and **Magenta**.
3. Press **▼** to highlight **Range** and press **◀/▶** to select the color range you wish to make adjustment. The bigger the range, the more proportions of its two adjacent colors the color contains.

Please refer to the illustration to the right for how the colors relate to each other. For example, if you select **Red** and set its range at 0, only pure red is selected. Increasing its range will include both the red color close to yellow and red color close to magenta.

4. Press **▼** to highlight **Saturation** and adjusts the color saturation level by pressing **◀/▶**. If you select **Red** and set its range at 0, only the saturation of the pure red will be affected.

 **Saturation is the amount of that color in a video picture. Lower settings produce less saturated colors; a setting of "0" removes that color from the image entirely. If the saturation is too high, that color will be overpowering and unrealistic.**

5. To leave and save the settings, press **MENU** once or **EXIT** twice.

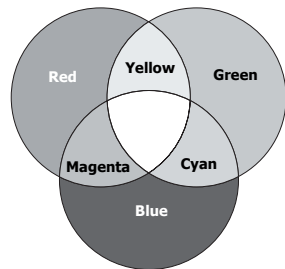

Selecting a Gamma setting

Highlight **Gamma Selection** and select a preferred setting by pressing ◀/▶ on the projector or remote control.

Gamma refers to the relationship between input source and picture brightness. The lower the figure, the more black detail is visible.

- Gamma 1, and 6
Increases the average brightness of the picture.
Best for a lit environment, meeting room or family room
- Gamma 2
Simulates the PC display standard.
- Gamma 3
Best for leveraging blackboards (or chalkboards) as projection screens.
- Gamma 4: Gamma Curve 2.2 sRGB standard
Best for viewing sRGB photos.
- Gamma 5, and 7
Best for viewing movies in a darkened environment
- Gamma 8
Emphasizes black detail.
Best setting to view movies with a lot of dark detail, shadows etc.



Color Space Transfer

In the unlikely event that you connect the projector to a TV set-top box via the projector's computer (data) based input (like **Analog RGB**, **DVI-A**, or **RJ-45**) and the projected picture displays wrong colors, please change the color space to **YUV**.



Operating in a high altitude environment

We recommend you activate **High Altitude Mode** when your environment is higher than 1500 meters (around 4920 feet) above sea level, or whenever the projector will be used for extended periods of time (>10 hours) without shutdown.

To activate **High Altitude Mode**:

1. Press **MENU** and then press ◀/▶ until the **Advanced Setup** menu is highlighted.
2. Press ▼ to highlight **High Altitude Mode**.
3. Press ◀/▶ to select **On**. A confirmation message displays.
4. Highlight **Yes** and press **ENTER**.

Operation under **High Altitude Mode** may cause a higher decibel operating noise level because of increased fan speed necessary to improve overall system cooling and performance.

If you use this projector under other extreme conditions excluding the above, it may display auto shut-down symptoms, which is designed to protect your projector from over-heating. In cases like this, you should switch to **High Altitude Mode** to solve these symptoms. However, this is not to state that this projector can operate under any and all harsh or extreme conditions.

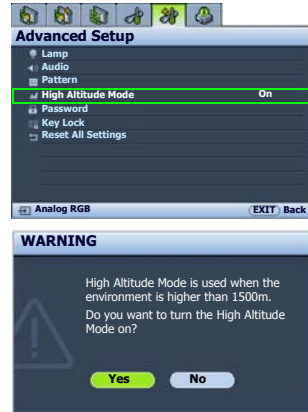

Hiding the picture

In order to draw the audience's full attention to the presenter, you can use **BLANK** to hide the screen picture. The word '**BLANK**' appears in the lower right corner of the screen while the picture is hidden. When this function is activated with an audio input connected, the audio can still be heard.

You can set a time length in the **System Setup > Blank Timer** menu to restore the picture after a period of time when there is no action taken on the projector or remote control. The length of time can be set from 5 to 30 minutes in 5-minute increments.

If the preset time spans are not suitable for your personation, select **Disable**.

No matter **Blank Timer** is activated or disabled, you can press any key (except **LASER**) anytime you want to restore the picture.

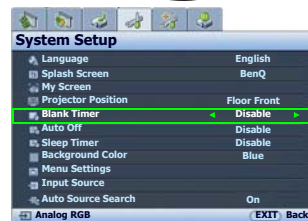
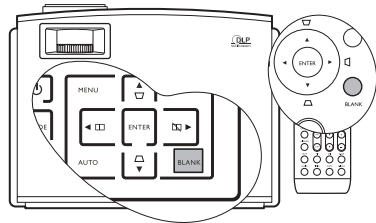

⚠ **Do not block the projection lens from projecting as this could cause the blocking object to become heated and deformed or even cause a fire.**

Displaying more than one picture source simultaneously

Your projector is capable of displaying pictures simultaneously from two input sources, which can be used to enhance your presentation in an interesting way. Ensure the signals you want to display are correctly connected to the projector.

Splitting the screen

The projector is able to display two input sources by dividing the projection equally into two screens on the left and right sides. That is each source uses 640 x 768 pixels at most of the projection. To display the split screen:

- **Using the projector or remote control**

Press **□** on the projector or **SPLIT SCREEN/ON** on the remote control to split the projection screen and press further until a desired way of display is selected.

To restore the projection to one big screen, press **□** or **SPLIT SCREEN/OFF**.

- **Using the OSD menu**

1. Press **MENU** and then press **◀/▶** until the **Display** menu is highlighted.
2. Press **▼** to highlight **Split Screen** and press **ENTER**. The **Split Screen** page displays.
3. Highlight **Split Screen** and press **◀/▶** to select **On**.

The projector will select two currently active signals to display and the last viewed picture will be displayed on the right side as a main source.

 See "**Split Screen and PIP source conflict list**" on page 53 for the conflict source combinations.

4. To change the **Left Source** or **Right Source**, press **▼** to highlight **Left Source** or **Right Source**, and press **ENTER**. The source selection page displays.
5. Use **▲/▼** to highlight the source you want to display for the left or right window, and press **ENTER** to save the setting and go back to the **Split Screen** page.
6. To make OSD settings to one of the two sources (Left or Right), highlight **Active Window**, and press **◀/▶** to select the source you want to make adjustments.

 The settings made on the OSD menu will only take effect on the active window. See "**Disabled functions for the active windows**" on page 53 for exceptions.

7. To change the way the pictures are displayed, highlight **Split Screen Relationship** and press **◀/▶** to select a desired way. See "**The Split Screen display way**" on page 53 for details.

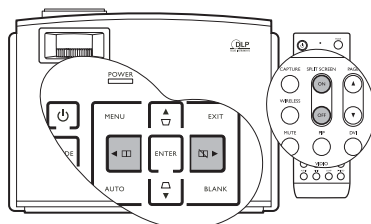

Split Screen and PIP source conflict list

The following source combinations cannot display at the same time for the **Split Screen** and **PIP** functions: **DVI-A+DVI-D**, **Component+Video**, **Component+S-Video**, **RJ-45+Video**, **RJ-45+S-Video**, and **Video+S-Video**.

Disabled functions for the active windows

The following OSD menu functions cannot work on the active windows for the **Split Screen**: **Digital Screen Shift**, **Digital Zoom**, **Pan**, **PIP**, **My Screen**, **Auto Source Search**, **Aspect Ratio**.

The following OSD menu functions cannot work on the active windows for the **PIP**: **Digital Screen Shift**, **Digital Zoom**, **Pan**, **Split Screen**, **My Screen**, **Auto Source Search**.

The Split Screen display way

- **Equally Split**



- **Proportional**

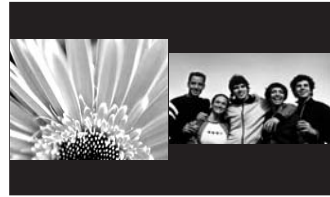

- **Left Large**

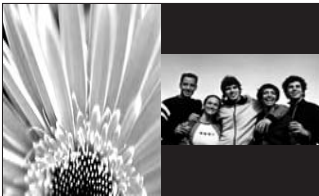

- **Right Large**

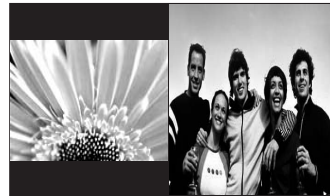

Creating your own startup screen

In addition to selecting the projector preset startup screen from among BenQ logo or Blue screen, you can make your own startup screen that is a picture projected from your computer or video source.

To create your own startup screen, project the picture you want to use as your startup screen from either a computer or video source. The rest steps are as follows.

• Using the remote control

1. Press **CAPTURE** on the remote control.
2. A confirmation message displays. Press **CAPTURE** or **ENTER** again.
3. The message 'Screen Capturing...' displays while the projector is processing the picture. Please wait.
4. If the action is successful, you see the message 'Captured Succeeded' on the screen. The captured picture is saved as **My Screen**.
5. To view the captured picture displayed as the startup screen, set **My Screen** in the **System Setup** > **Splash Screen** menu and restart the projector.

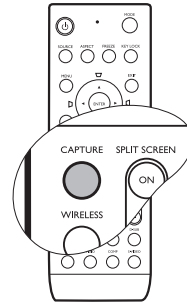

• Using the OSD menu

1. Press **MENU** and then press ◀/▶ until the **System Setup** menu is highlighted.
2. Press ▼ to highlight **My Screen** and press **ENTER**.
3. Repeat steps 2-5 in the “Using the remote control” section to capture and view the captured picture.

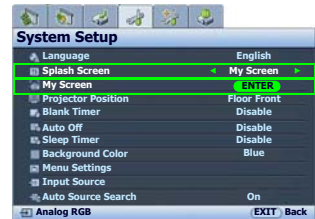

In the unlikely event that the capturing action fails, change your target picture.

Personalizing the projector menu display

The On-Screen Display (OSD) menus can be set according to your preferences. The following settings do not affect the projection settings, operation, or performance.

- **Rename User Mode:** See "Renaming user modes" on page 44 for details.
- **Menu Display Time** in the **System Setup** > **Menu Settings** menu sets the length of time the OSD will remain active after your last key press. The time length ranges from 5 to 30 seconds in 5-second increments. Use ◀/▶ to select a suitable time.
- **Menu Position** in the **System Setup** > **Menu Settings** menu sets the OSD position in five locations. Use ◀/▶ to select a preferred position.
- **Language** in the **System Setup** menu sets your familiar language for the On-Screen (OSD) Menus. See "Using the menus" on page 31 for details.
- **Splash Screen** in the **System Setup** menu sets a preferred logo screen to be displayed during projector start-up. See "Creating your own startup screen" on page 54 for details.

Adjusting the sound

The sound adjustments made as below will have an effect on the projector speaker and, if using external speakers, on the audio output signal.

Be sure you have made a correct connection to the projector audio input(s) and, if using external speakers, to the projector audio outputs. See "[Connecting Audio device](#)" on page 29 for details.

Muting the sound

Press **MUTE** on the remote control to temporarily turn off the sound. While the sound is off, the screen will display  in the upper right corner of the screen.

To restore the sound, press **MUTE** again.

You can also toggle the audio between on and off in the **Advanced Setup > Audio** menu. See the OSD picture on this page for details.

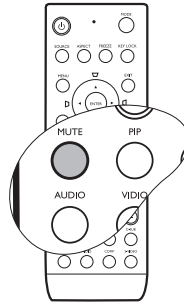

Other sound adjustments

1. Press **AUDIO** on the remote control to display the **Audio** page.
(The secondary option to access the **Audio** menu is to press **MENU** to open the OSD menu, highlight **Audio** in the **Advanced Setup** menu, and press **ENTER**.)
2. To adjust the sound volume, press ▼ to highlight **Volume** and press ◀/▶ to adjust the level.
3. To adjust the sound treble, press ▼ to highlight **Treble** and press ◀/▶ to adjust the level.
4. To adjust the sound bass, press ▼ to highlight **Bass** and press ◀/▶ to adjust the level.

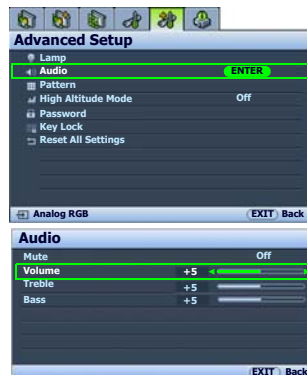

Selection	◀ Pressing ▶	
Volume	smaller	louder
Treble	weaker	stronger
Bass	weaker	stronger

Remote paging operations

Connect the projector to your PC or notebook with a USB cable prior to using the paging function. See "Connecting a computer" on page 23 for details.

You can operate your display software program (on a connected PC) which responds to page up/down commands (like Microsoft PowerPoint) by pressing **PAGE ▲/▼** on the remote control.

If remote paging function doesn't work, check if the USB connection is correctly made and the mouse driver on your computer is updated to the latest version.

 **The remote paging function cannot work with Microsoft® Windows®98 operating system. Windows®XP or higher operating systems are recommended.**

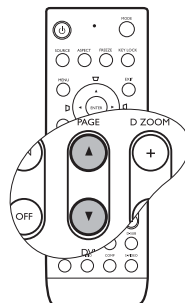

Freezing the picture

Press **FREEZE** on the remote control to freeze the picture. 'FREEZE' will display in the upper right corner of the screen. To release the function, press any key (except **LASER**) on the projector or remote control.

Even if a picture is frozen on the screen, the pictures are running on the video or other device. If the connected devices have active audio output, you will still hear the audio even though the picture is frozen on screen.

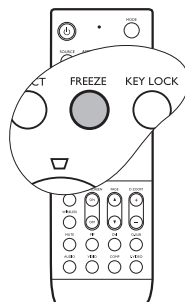

Locking control keys

With the control keys on the remote control and projector locked, you can prevent your projector settings from being changed accidentally (by children, for example). When the Key Lock is on, no control keys on the remote control and projector will operate except **LASER** and **EXIT**.

To lock the keys:

- **Using the remote control**

Press **KEY LOCK** on the remote control. The control keys lock.

- **Using the OSD menu**

1. Press **MENU** and then press **◀/▶** until the **Advanced Setup** menu is highlighted.
2. Press **▼** to highlight **Key Lock**, and press **ENTER**.
The control keys lock.

To unlock the keys, press and hold **EXIT** on the projector for 5 seconds or press **EXIT** on the remote control.

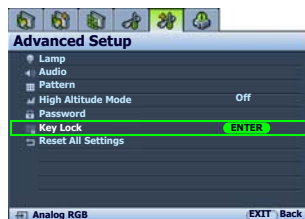

Shutting down the projector

1. Press **Power** on the remote control or projector and a confirmation message will display prompting you.
If you don't respond in a few seconds, the message will disappear.
2. Press **Power** a second time. The **Power indicator light** flashes orange, the projection lamp shuts down, and the fans will continue to run for approximately 90 seconds to cool down the projector.

 **To protect the lamp, the projector will not respond to any commands during the cooling process.**

3. The Power indicator light is a steady orange once the cooling process has finished and fans stop.
4. Disconnect the power cord from the wall socket.

 **To save your time, you can unplug the projector as soon as it is turned off without waiting for the cooling time. The projector will continue cooling down even if it is unplugged so that you can pack up the projector and go. During the projector's off-line cooling, you cannot restart it.**

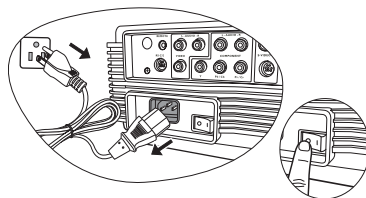
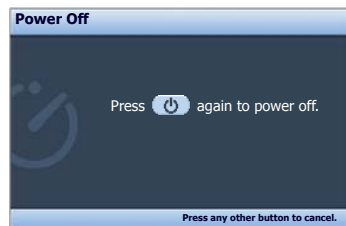
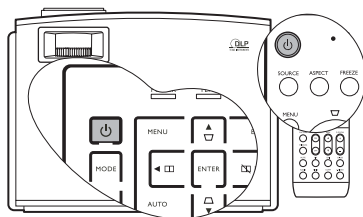

Menu operation

On-Screen Display menu structure

Please note that the on-screen display (OSD) menus vary according to the signal type selected.

Main menu	Sub-menu	Options	
Picture -- Basic	Picture Mode	(PC) Dynamic/Presentation/sRGB/Cinema/Blackboard/User 1/User 2/User 3 (Video) Dynamic/Standard/Cinema/User 1/User 2/User 3	
	Load Settings From		
	Brightness	0–100	
	Contrast	0–100	
	Color	0–100	
	Tint	-20–+20	
	Sharpness	0–8	
	Reset Picture Settings		
	Rename User Mode		
	Black Level	0 IRE/7.5 IRE	
	Clarity Control	Noise Reduction	0/1/2/3
Detail Enhancement		0–10	
LTI		0/1/2	
CTI		0/1/2	
Color Temperature	Lamp Native/Warm/Normal/Cool/User 1/User 2/User 3		
Picture -- Advanced	Red Gain	0–100	
	Green Gain	0–100	
	Color Temp User_	Blue Gain 0–100	
	Fine Tuning	Red Offset	0–100
		Green Offset	0–100
		Blue Offset	0–100
	Gamma Selection	Gamma 1-8	
Color Management	Primary Color	Red/Yellow/Green/Cyan/Blue/Magenta	
	Range	0–100	
	Saturation	0–100	
Color Space Transfer	Default/RGB/YUV		
Signal Shuttle	(Refer to the Signal Shuttle user manual for details.)		

Display	Aspect Ratio	4:3/Anamorphic/Fill/Letter Box/Wide/Real	
	Digital Screen Shift	-24→+24	
	Keystone	2D Keystone	
		Pincushion Correction	-20→+20
	Attachable Lens Position	On/Off	
	Overscan Adjustment	0/1/2/3	
	Digital Zoom	100%–300%	
	Pan		
	PIP	PIP	On/Off
		Main Source	Analog RGB/DVI-A/DVI-D/RJ-45/S-Video/Component/Video
		Second Source	Video/Component/Video
		Active Window	Main/Second
		Position	Top-Right/Top-Left/Bottom-Right/Bottom-Left
		Size	Large/Small
	Split Screen	Split Screen	On/Off
		Split Screen Relationship	Equally Split/Proportional/Left Large/Right Large
		Left Source	Analog RGB/DVI-A/DVI-D/RJ-45/S-Video/Component/Video
		Right Source	Video/Component/Video
		Active Window	Left/Right
	PC & Component YPbPr Tuning	H.Size	-15→+15
Phase		-15→+15	
Auto			

System Setup	Language	ENGLISH/繁體中文/FRAANÇAIS/ ESPAÑOL/DEUTSCH/ITALIANO/ 简体中文/한국어/日本語/ РУССКИЙ/Nederlands/Português/ Svenska/Čeština/PolSKI		
	Splash Screen	BenQ/Blue/My Screen		
	My Screen			
	Projector Position	Floor Front/Ceiling Front/Floor Rear/Ceiling Rear		
	Blank Timer	Disable/5 min/10 min/15 min/20 min/25 min/30 min		
	Auto Off	Disable/5 min/10 min/15 min/20 min/25 min/30 min		
	Sleep Timer	Disable/30 min/60 min/90 min/120 min/150 min/180 min/240 min/300 min/360 min		
	Background Color	Purple/Black/Blue		
	Menu Settings	Menu Display Time	5 sec/10 sec/15 sec/20 sec/25 sec/30 sec	
		Menu Position	Center/Top-Left/Top-Right/Bottom-Right/Bottom-Left	
	Input Source	Analog RGB/DVI-A/DVI-D/RJ-45/S-Video/Component/Video		
	Auto Source Search	On/Off		
	Advanced Setup	Lamp	Lamp Power	Normal/Eco.
Lamp Hours			(shows lamp hours information)	
Reset Lamp Timer				
Audio		Mute	On/Off	
		Volume	0–10	
		Treble	0–10	
		Bass	0–10	
Pattern		Grid		
		Color Bar		
High Altitude Mode		On/Off		
Password	Password	On/Off		
	Change Password	(inputs current password)		
Key Lock				
Reset All Settings				
Information	Source			
	Picture Mode			
	Resolution			
	System			
	Lamp Hours	Normal		
Eco.				

Note that the menu items are available when the projector detects at least one valid signal. If there is no equipment connected to the projector or no signal detected, limited menu items are accessible.

Picture -- Basic menu

FUNCTION (default setting/ value)	DESCRIPTION (default setting/value)
Picture Mode (Analog RGB/ DVI-A/DVI-D/RJ- 45: Presentation; S-Video/ Component/ Video: Standard)	Pre-defined picture modes are provided so you can optimize your projector picture set-up to suit your program type. See "Selecting a picture mode" on page 42 for details.
Load Settings From	Selects a picture mode that most suits your need for the picture quality and further fine-tune the picture based on the selections listed below. See "Setting the User 1/User 2/User 3 mode" on page 43 for details.
Brightness (depends on the selected input source)	Adjusts the brightness of the picture. See "Adjusting Brightness" on page 45 for details.
Contrast (depends on the selected input source)	Adjusts the degree of difference between dark and light in the picture. See "Adjusting Contrast" on page 45 for details.
Color (depends on the selected input source)	Adjusts the color saturation level -- the amount of each color in a video picture. See "Adjusting Color" on page 45 for details.
Tint (depends on the selected input source)	Adjusts the red and green color tones of the picture. See "Adjusting Tint" on page 45 for details.
Sharpness (2)	Adjusts the picture to make it look sharper or softer. See "Adjusting Sharpness" on page 45 for details.
Reset Picture Settings	Returns all settings in the Picture -- Basic and Picture -- Advanced menus to the factory preset values. See "Resetting the picture mode" on page 44 for details.
Rename User Mode	Renames User 1 , User 2 , or User 3 . See "Renaming user modes" on page 44 for details.

Picture -- Advanced menu

FUNCTION (default setting / value)	DESCRIPTION
Black Level (0 IRE)	Sets the picture grayscale as 0 IRE or 7.5 IRE . See " Setting Black Level " on page 46 for details.
Clarity Control	Adjusts the picture clarity. See " Controlling image clarity " on page 46 for details.
Color Temperature (depends on the selected Picture Mode)	There are several color temperature settings available. See " Selecting a color temperature* " on page 47 for details.
Color Temp User_Fine Tuning	See " Setting a preferred color temperature " on page 47 for details.
Gamma Selection (depends on the selected Picture Mode)	See " Selecting a Gamma setting " on page 49 for details.
Color Management	See " Color Management " on page 48 for details.
Color Space Transfer (Default)	See " Color Space Transfer " on page 49 for details.
Signal Shuttle	Adjusts the picture quality projected via the RJ-45 signal. This menu is available when the optional accessory–Signal Shuttle is connected and the RJ-45 signal is detected. You can purchase Signal Shuttle through BenQ retailers.

Display menu

FUNCTION (default setting / value)	DESCRIPTION
Aspect Ratio (Fill)	There are several options to set the picture's aspect ratio depending on your input source. See " Selecting the aspect ratio " on page 39 for details.
Digital Screen Shift (0)	Adjusts the vertical position of the projected picture. See " Shifting the picture around the black areas " on page 39 for details.
Keystone (0)	Corrects any keystone of the picture. See " Correcting picture distortion " on page 37 for details.
Position (0)	Displays the position adjustment page. To move the projected picture, use the directional arrow keys. The values shown on the lower position of the page change with every key press you made until they reach their maximum or minimum.
Overscan Adjustment (S-Video/Video: 1; the rest: 0)	Conceals the poor picture quality in the four edges. You can also manually press ◀/▶ to decide how much to be concealed. Setting 0 means the picture is 100% displayed. The greater the value, the more portion of the picture is concealed while the screen remains filled and geometrically accurate.
Digital Zoom (100%)	Magnifies the projected picture. See " Magnifying and Searching for details on the projected picture " on page 41 for details.
Pan (Central)	Displays the Pan page for searching the details of the projected picture after the picture is magnified. See " Magnifying and Searching for details on the projected picture " on page 41 for details.
PIP	Turns the PIP window on or off and makes related adjustments. See " PIP (Picture In Picture) operation " on page 52 for details.
Split Screen	Divides the projection screen into two equal parts and makes related adjustments. See " Splitting the screen " on page 51 for details.
PC & Component YPbPr Tuning	<p>H.Size (0) Adjusts the horizontal width of the picture.</p> <p>Phase (0) Adjusts the clock phase to reduce picture distortion.</p> <p>Auto Adjusts the phase, and frequency automatically</p> 

System Setup menu

FUNCTION (default setting / value)	DESCRIPTION
Language (English)	Sets the language for the On-Screen Display (OSD) menus. See "Using the menus" on page 31 for details.
Splash Screen (BenQ logo)	Allows you to select which logo screen will display during projector start-up. Three options are available: BenQ logo screen, Blue screen, or My Screen .
My Screen	Captures and stores the projected picture as My Screen. See "Creating your own startup screen" on page 54 for details.
Projector Position (Floor Front)	The projector can be installed on a ceiling or behind a screen, or with one or more mirrors. See "Choosing a location" on page 17 for details.
Blank Timer (Disable)	Sets the picture blank time when the Blank feature is activated, once elapsed the projector will restore the picture. See "Hiding the picture" on page 50 for details.
Auto Off (Disable)	Prevents unnecessary projection when no signal is detected for a long time. See "Setting Auto Off" on page 68 for details.
Sleep Timer (Disable)	Sets the auto-shutdown timer. The timer can be set to a value between 30 minutes and 3 hours.
Background Color (Blue)	Allows you to choose the color of the background screen that will be displayed when there is no input signal detected.
Menu Settings	<p>Menu Display Time (15 sec) Sets the length of time the OSD will remain active after your last key press. The range is from 5 to 30 seconds in 5-second increments.</p> <p>Menu Position (Center) Sets the On-Screen Display (OSD) menu position.</p>
Input Source	Selects an input source to be projected. See "Switching input source" on page 35 for details.
Auto Source Search (On)	Sets whether the projector searches automatically for input sources. If the source scan is On , the projector will scan for input sources until it acquires a signal. If the function is not activated, the projector selects the last used input source. The default value is ' Analog RGB '.

Advanced Setup menu

FUNCTION (default setting / value)	DESCRIPTION
Lamp	<p>Lamp Power (Normal) Selects the projector lamp between Normal and Eco. (Economic) modes.</p> <p>Lamp Hours Shows the lamp hours information. See "Getting to know the lamp hour" on page 68 for details.</p> <p>Reset Lamp Timer Once the lamp is renewed, select Reset to return the lamp timer to '0'. See "Resetting the lamp timer" on page 72 for details.</p>
Audio	<p>Mute (Off) Toggles the projector audio between on and off.</p> <p>Volume (5) Adjusts audio volume level.</p> <p>Treble (5) Adjusts the treble level.</p> <p>Bass (5) Adjusts the bass level.</p> <p>See "Adjusting the sound" on page 55 for details.</p>
Pattern	<p>Grid Press ENTER to display the grid test pattern. It helps you adjust the image size and focus and check that the projected image is free of distortion.</p> <p>Color Bar Press ENTER to display the color bar test pattern. You can display this test pattern to check that the colors are to your liking.</p>
High Altitude Mode (Off)	<p>A mode for operation in areas like high altitude or high temperature. See "Operating in a high altitude environment" on page 50 for details.</p>
Password	<p>Password (Off) Limits use of the projector to only those who know the correct password. See "Utilizing the password function" on page 32 for details.</p> <p>Change Password You will be asked to enter the current password before changing to a new one. See "Utilizing the password function" on page 32 for details.</p>
Key Lock	<p>Locks the keys on the projector and remote control except LASER and EXIT. See "Locking control keys" on page 56 for details.</p>
Reset All Settings	<p>Returns all settings in the Picture -- Basic menu to the factory preset values.</p> <p> The following settings will still remain: Names of user modes, Keystone, Position, H.Size, Phase, Language, Projector Position, High Altitude Mode, Lamp, and Password.</p>

Information menu

This menu shows you the current operating status of the projector.

 **Some picture adjustments are available only when certain input sources are in use. Unavailable adjustments are not shown on the screen.**

FUNCTION	DESCRIPTION
Source	Shows the current signal source.
Picture Mode	Shows the selected mode in the Picture -- Basic > Picture Mode menu.
Resolution	Shows the native resolution of the input source.
System	Shows the current system: NTSC, PAL, or SECAM.
Lamp Hours	Shows the lamp time used under Normal and Eco . modes.

6. Maintenance

Care of the projector

Your projector needs little maintenance. The only thing you need to do on a regular basis is to keep the lens clean. See "[Cleaning the lens](#)" below for details.

Never remove any parts of the projector except the lamp. Contact your dealer if other parts need replacing.

Cleaning the lens

Clean the lens whenever you notice dirt or dust on the surface.

- Use a canister of compressed air to remove dust.
- If there is dirt or smears, use lens-cleaning paper or moisten a soft cloth with lens cleaner and gently wipe the lens surface.

 **Never rub the lens with abrasive materials.**

Cleaning the projector case

Before you clean the case, turn the projector off using the proper shutdown procedure as described in "[Shutting down the projector](#)" on page 57 and unplug the power cord.

- To remove dirt or dust, wipe the case with a soft, dry, lint-free cloth.
- To remove stubborn dirt or stains, moisten a soft cloth with water and a neutral pH detergent. Then wipe the case.

 **Never use wax, alcohol, benzene, thinner or other chemical detergents. These can damage the case.**

Storing the projector

If you need to store the projector for an extended time, please follow the instructions below:

- Make sure the temperature and humidity of the storage area are within the recommended range for the projector. Please refer to "[Specifications](#)" on page 76 or consult your dealer about the range.
- Retract the adjuster feet.
- Remove the batteries from the remote control.
- Pack the projector in its original packing or equivalent.

Transporting the projector

It is recommended that you ship the projector with its original packing or equivalent.

Lamp information

Getting to know the lamp hour

When the projector is in operation, the duration (in hours) of lamp usage is automatically calculated by the built-in timer. The method of calculating the equivalent lamp hour is as follows:

Equivalent lamp hour

= 1 (hours used in Economic mode) + 4/3 (hours used in normal mode)

☞ See "**Setting Lamp Power as Eco.**" below for more information on **Eco. mode**.

To obtain the lamp hour information:

1. Press **MENU** and then press **◀/▶** until the **Advanced Setup** menu is highlighted.
2. Press **▼** to highlight **Lamp** and press **ENTER**. The **Lamp** page displays.
3. Highlight **Lamp Hours** and press **ENTER** to display the **Lamp Hours** information page.
4. To leave the menu, press **MENU**.

About Lamp Rest Rate:

Lamp Rest Rate shows the percentage of the lamp rest life. The method of calculating the rate is as follows:

Rest Rate = $[1 - (\text{Total Lamp Hours} / 4000)] \times 100\%$

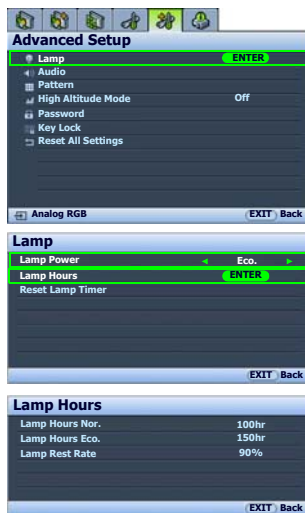

Extending lamp life

The projection lamp is a consumable item that normally can last up to 3000-4000 hours with proper usage. To keep the lamp life as long as possible, you can do the following settings via the OSD menu.

• Setting Lamp Power as Eco.

Using **Eco.** mode reduces system noise and power consumption by 20%. If the **Eco.** mode is selected, the light output will be reduced and result in darker projected pictures.

Setting the projector in **Eco.** mode also extends the lamp timer automatic shutdown feature.

To set **Eco.** mode, go into the **Advanced Setup > Lamp > Lamp Power** menu and press **◀/▶**.

• Setting Auto Off

This function allows the projector to turn off automatically if no input source is detected after a set period of time.

To set **Auto Off**, go into the **System Setup > Auto Off** menu and press **◀/▶**. The time period can be set from 5 to 30 minutes in 5-minute increments. If the preset time lengths are not suitable for your presentation, select **Disable**. The projector will not automatically shut down in a certain time period.

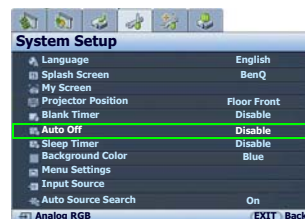

Timing of replacing the lamp

When the **Lamp indicator** lights up red or a message appears suggesting it is time to replace the lamp, please install a new lamp or consult your dealer. An old lamp may cause a malfunction in the projector and in some instances the lamp may explode.

The Lamp indicator light and Temperature warning light will light up if the lamp becomes too hot. Turn the power off and let the projector cool for 45 minutes. If the Lamp or Temp indicator still lights up after turning the power back on, please contact your dealer. See "[Indicators](#)" on page 73 for details.

The following Lamp warning displays will remind you to change the lamp.

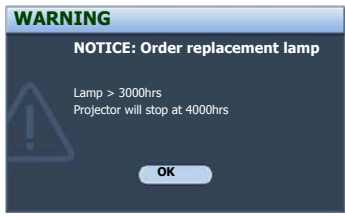
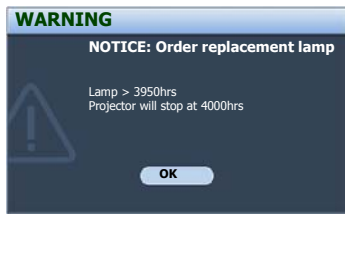
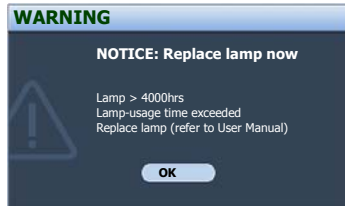
Status	Message
<p>The lamp has been in operation for 3000 hours. Install a new lamp for optimal performance. If the projector is normally run with Eco, selected (See "Getting to know the lamp hour" on page 68), you may continue to operate the projector until the 3950 hour lamp warning appears.</p> <p>Press ENTER to dismiss the message.</p>	 <p>WARNING</p> <p>NOTICE: Order replacement lamp</p> <p>Lamp > 3000hrs Projector will stop at 4000hrs</p> <p>OK</p>
<p>The lamp has been in operation for 3950 hours. It is strongly recommended that you replace the lamp at this age. The lamp is a consumable item. The lamp brightness diminishes with use. This is normal lamp behavior. You can replace the lamp whenever you notice that the brightness level has significantly diminished. If the lamp is not replaced beforehand, it should be replaced after 3950 hours usage.</p> <p>Press ENTER to dismiss the message.</p>	 <p>WARNING</p> <p>NOTICE: Order replacement lamp</p> <p>Lamp > 3950hrs Projector will stop at 4000hrs</p> <p>OK</p>
<p>The lamp has been in operation for 4000 hours. The lamp MUST be replaced before the projector will operate normally.</p> <p>Press ENTER to dismiss the message.</p>	 <p>WARNING</p> <p>NOTICE: Replace lamp now</p> <p>Lamp > 4000hrs Lamp-usage time exceeded Replace lamp (refer to User Manual)</p> <p>OK</p>

Replacing the lamp

- ⚠ • To reduce the risk of electrical shock, always turn the projector off and disconnect the power cord before changing the lamp.
- To reduce the risk of severe burns, allow the projector to cool for at least 45 minutes before replacing the lamp.
- To reduce the risk of injuries to fingers and damage to internal components, use caution when removing lamp glass that has shattered into sharp pieces.
- To reduce the risk of injuries to fingers and/or compromising picture quality by touching the lens, do not touch the empty lamp compartment when the lamp is removed.
- This lamp contains mercury. Consult your local hazardous waste regulations to dispose of this lamp in a proper manner.

1. Turn the power off and disconnect the projector from the wall socket. If the lamp is hot, avoid burns by waiting for approximately 45 minutes until the lamp has cooled.
2. Turn the projector over. Then loosen the screw on the lamp cover.

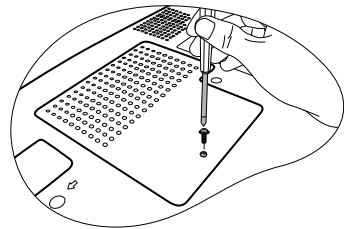

3. Remove the lamp cover from the projector.

- ⚠ Do not turn the power on with the lamp cover removed.

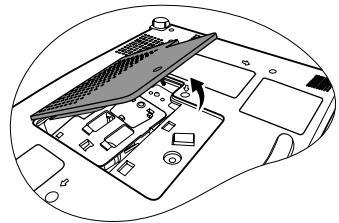

4. Loosen the screw that secures the lamp.

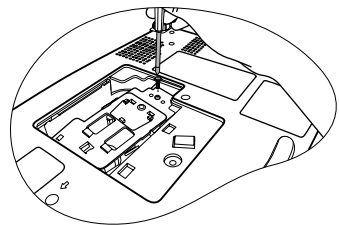

5. Lift the handle so that it stands up. Use the handle to slowly pull the lamp out of the projector.

- ☞ • **Pulling it too quickly may cause the lamp to break and scatter broken glass in the projector.**
- **Do not place the lamp in locations where water might splash on it, children can reach it, or near flammable materials.**
- **Do not insert your hands into the projector after the lamp is removed. If you touch the optical components inside, it could cause color unevenness and distortion of the projected pictures.**

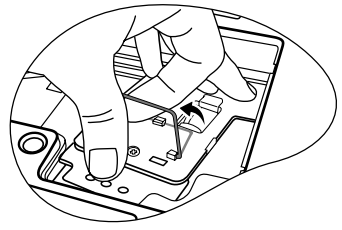

6. As shown in the figure, hold the new lamp and align the two locators on the lamp with the holes on the projector, and then insert the lamp all the way into the projector.

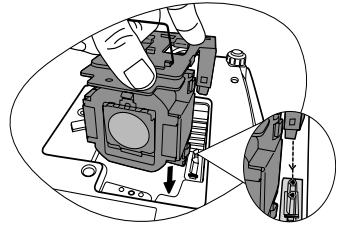

7. Tighten the screw that secures the lamp.

- ☞ • **Loose screw may cause a bad connection, which could result in malfunction.**
- **Do not over tighten the screw.**

8. Ensure the handle is fully laid flat and locked in place.

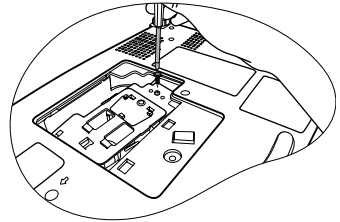

9. Replace the lamp cover on the projector.

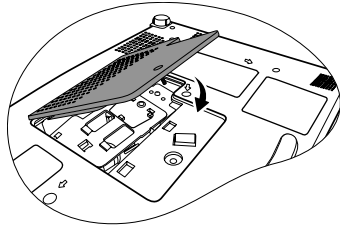

10. Tighten the screw that secures the lamp cover.

- ☞ • **Loose screw may cause a bad connection, which could result in malfunction.**
- **Do not over tighten the screw.**

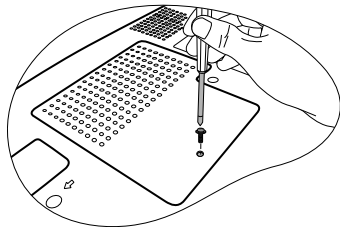

11. Restart the projector.

- ☞ • **Do not turn the power on with the lamp cover removed.**

Resetting the lamp timer

12. After the startup logo, press **MENU** and then press **◀/▶** until the **Advanced Setup** menu is highlighted.
13. Press **▼** to highlight **Lamp** and press **ENTER**. The **Lamp** page displays.
14. Highlight **Reset Lamp Timer** and press **ENTER**. A warning message displays asking if you want to reset the lamp timer. Highlight **Reset** and press **ENTER**. The lamp time will be reset to '0'.

 **Do not reset if the lamp is not new or replaced as this could cause damage.**

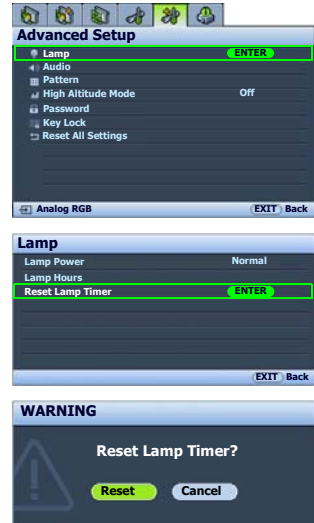

Indicators

Light			Status & Description
Power	Temp	Lamp	
Orange	Orange	Orange	The projector has just been connected to a power outlet.
Orange	Red	Red	Main power switch on
Orange	Off	Off	Stand-by mode
Green Flashing	Off	Off	Powering up
Green	Off	Off	Normal operation
Orange Flashing	Off	Off	<ul style="list-style-type: none"> The projector needs 90 seconds to cool down as it was abnormally shut down without the normal cooling down process. The projector needs to cool for 90 seconds after the power is turned off.
Off	Off	Red	<ul style="list-style-type: none"> The lamp has been damaged. Please contact your local BenQ customer center for purchasing a new lamp.
Orange	Off	Red	<ul style="list-style-type: none"> The lamp is not properly attached. The lamp has been damaged. Please contact your local BenQ customer center for purchasing a new lamp.
Off	Red	Off	<p>The projector has shutdown automatically. If you try to re-start the projector, it will shutdown again. Please contact your dealer for assistance.</p>
Off	Red	Red	
Off	Red	Green	
Off	Red	Orange	
Red	Red	Red	
Red	Red	Green	
Red	Red	Orange	
Green	Red	Red	
Green	Red	Green	
Green	Red	Orange	
Orange	Red	Red	
Orange	Red	Green	
Orange	Red	Orange	
Off	Green	Red	
Off	Green	Orange	
Off	Orange	Red	

7. Troubleshooting

? The projector does not turn on.

Cause	Remedy
There is no power from the power cable.	Plug the power cord into the AC inlet on the projector, and plug the power cord into the power outlet. If the power outlet has a switch, make sure that it is switched on.
Attempting to turn the projector on again during the cooling process.	Wait until the cooling down process has completed.

? No picture

Cause	Remedy
The video source is not turned on or connected correctly.	Turn the video source on and check that the signal cable is connected correctly.
The projector is not correctly connected to the input source device.	Check the connection.
The input source has not been correctly selected.	Select the correct input source with the SOURCE key on the projector or remote control.
The lens cap is still attached to the lens.	Remove the lens cap.

? Blurred picture

Cause	Remedy
The projection lens is not correctly focused.	Adjust the focus of the lens using the focus ring.
The projector and the screen are not aligned properly.	Adjust the projection angle and direction as well as the height of the unit if necessary.
The lens cap is still attached to the lens.	Remove the lens cap.

? Remote control does not work

Cause	Remedy
The batteries are out of power.	Replace the batteries with new ones.
There is an obstacle between the remote control and the projector.	Remove the obstacle.
You are too far away from the projector.	Stand within 6 meters (19.5 feet) of the projector.

? The Temperature warning light is flashing red.

Cause	Remedy
The internal temperature is too high or the fans are not working.	Turn the projector off and contact qualified service personnel for further help. See "Indicators" on page 73 for details.

② **The computer projected picture is too big for the screen or appeared to be cut-off**

Cause	Remedy
The computer's resolution does not match the projector's resolution.	<ol style="list-style-type: none"> 1. Make sure the H Position and V Position settings are correct in the Display > Position menu. 2. Configure the computer's external display resolution to the projector's native resolution (1280 x 768 for SP830/ SP831). If this option is not available, select one of the compatible listed in "Supported timing for PC (including DVI-I) input" on page 77. 3. Check if your presentation files are created for a different resolution.
The computer's external monitor setting is locked in 640 x 480.	

② **My Window Media Player program works great on my computer, but the movie window is dark on my projector, while the Media Player tools display OK.**

Cause	Remedy
The computer external display is set as a secondary display.	Change the Display settings. Click Start > Control Panel > Display > Settings > Advanced > Display. See your computer documentation for details, if you cannot find the Display settings by following the instructions above. Set the Monitor to Primary, and the Panel to Secondary. You will see the movie window on the projection screen, while the Panel movie window will be dark.

② **The remote mouse function does not work.**

Cause	Remedy
The USB cable is not correctly connected to the projector or computer.	Check the connection. See " Connecting a computer " on page 23 for details. If it still doesn't work, check the mouse driver. See the mouse documentation for details.

② **The picture contains static or noise.**

Cause	Remedy
You are using a computer cable longer than 6 feet (2 meters), or an extension cable.	Change you signal cable to a regular length and avoid using extension cables.
Your computer and video cables interfere with each other.	Keep your computer and video cables away from the power cord as much as possible to prevent interference.

8. Specifications

Projector specifications

 All specifications are subject to change without notice.

Optical

Resolution
1280 x 768 WXGA

Display system
1-CHIP DMD

Lens F/Number
F=2.4 to 2.58, f= 22.32 to 26.06 mm

Lamp
300 W lamp

Electrical

Power supply
AC100–240V, 4.5A, 50-60 Hz (Automatic)

Power consumption
450 W (Max); 1.5 W (Standby)

Mechanical

Weight
10 lbs (4.5 Kg)

Output terminals

RGB output
D-Sub 15-pin (female) x 1

Audio output
RCA audio jack (L/R)

Speaker
(Stereo) 2 watt x 2

Control

USB serial control
Type mini B

RS-232 serial control
Mini Din 8 pin x 1

Input terminals

Computer input
RGB input
D-Sub 15-pin (female) x 1
DVI-I input
RJ-45 x 1

Video signal input
S-VIDEO
Mini DIN 4-pin port x 1
VIDEO
RCA jack x 1
SD/HDTV signal input
Analog - Component RCA jack x 3
Digital - DVI (HDCP support)

Audio signal input
Audio in
PC audio jack
for D-Sub, DVI (HDCP) signals
RCA audio jack (L/R)
for Video, S-Video, Component signals

Environmental Requirements

Operating temperature
0°C–40°C at sea level

Operating relative humidity
10%–90% (without condensation)

Operating altitude
0–1499 m at 0°C–35°C
1500–3000 m at 0°C–30°C (with High Altitude Mode on)

Timing chart

Supported timing for PC (including DVI-I) input

Resolution	Horizontal Frequency (kHz)	Vertical Frequency (Hz)	Pixel Frequency (MHz)	Mode
720 x 400	31.469	70.087	28.3221	720 x 400_70
640 x 480	31.469	59.940	25.175	VGA_60
	37.861	72.809	31.500	VGA_72
	37.500	75.000	31.500	VGA_75
	43.269	85.008	36.000	VGA_85
800 x 600	37.879	60.317	40.000	SVGA_60
	48.077	72.188	50.000	SVGA_72
	46.875	75.000	49.500	SVGA_75
	53.674	85.061	56.250	SVGA_85
1024 x 768	48.363	60.004	65.000	XGA_60
	56.476	70.069	75.000	XGA_70
	60.023	75.029	78.750	XGA_75
	68.667	84.997	94.500	XGA_85
1280 x 768	47.776	59.87	79.5	WXGA_60
1280 x 1024	63.981	60.020	108.000	SXGA_60
	79.976	75.025	135.000	SXGA_75
	*91.146	*85.024	*157.500	*SXGA_85
1280 x 960	60.000	60.000	108	1280 x 960_60
	85.938	85.002	148.500	1280 x 960_85
1440 x 900	55.935	59.887	106.500	WXGA+_60
	70.635	74.984	136.750	WXGA+_75
	*80.430	*84.842	*157.000	*WXGA+_85
1400 x 1050	65.317	59.978	121.750	SXGA+_60
	*82.278	*74.867	*156.000	*SXGA+_75
1680 x 1050	65.290	59.954	146.250	Vista
**1600 x 1200	75.000	60.000	162.000	UXGA
VIDEO (HDCP) (Only for DVI-D input)	15.75	60	13.51	480i
	31.47	60	27	480p
	15.63	50	13.5000	576i
	31.25	50	27.000	576p
	45.00	60	74.25	720p_60
	37.50	50	74.25	720p_50
	33.75	60	74.25	1035i
	67.5	60	148.5	1035p
	33.75	60	74.25	1080i_60
	28.13	50	74.25	1080i_50
67.5	60	148.5	1080p	

 * denotes the timing may not support on using with the DVI-A or DVI-D input signal selected.

** denotes the timing may not support on using with the DVI-D input signal selected, or using the splitting screen.

Supported timing for Component Video input

Signal Format	Horizontal Frequency (kHz)	Vertical Frequency (Hz)
480i(525i)@60Hz	15.73	59.94
480p(525p)@60Hz	31.47	59.94
576i(625i)@50Hz	15.63	50.00
576p(625p)@50Hz	31.25	50.00
720p(750p)@60Hz	45.00	60.00
720p(750p)@50Hz	37.50	50.00
1080i(1125i)@60Hz	33.75	60.00
1080i(1125i)@50Hz	28.13	50.00
1080p@60Hz	67.5	60.00

Supported timing for Video and S-Video inputs

Video mode	Horizontal Frequency (kHz)	Vertical Frequency (Hz)	Color sub-carrier Frequency (MHz)
NTSC	15.73	60	3.58
PAL	15.63	50	4.43
SECAM	15.63	50	4.25 or 4.41
PAL-M	15.73	60	3.58
PAL-N	15.63	50	3.58
PAL-60	15.73	60	4.43
NTSC4.43	15.73	60	4.43

Dimensions

277 mm (W) x 115 mm (H) x 375 mm (D)

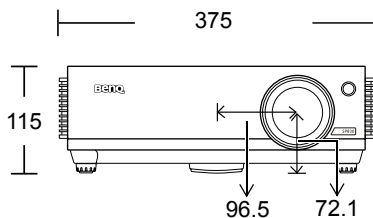
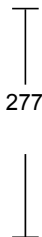
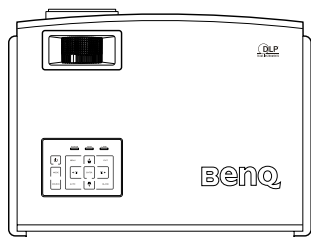

Unit: mm

9. Warranty and Copyright information

Limited warranty

BenQ warrants this product against any defects in material and workmanship, under normal usage and storage.

Proof of purchase date will be required with any warranty claim. In the event this product is found to be defective within the warranty period, BenQ's only obligation and your exclusive remedy shall be replacement of any defective parts (labor included). To obtain warranty service, immediately notify the dealer from which you purchased the product of any defects.

Important: The above warranty shall be void if the customer fails to operate the product in accordance with BenQ's written instructions, especially the ambient humidity must be in-between 10% and 90%, temperature in-between 0°C and 40°C, altitude lower than 10000 feet, and avoiding to operate the projector in a dusty environment. This warranty gives you specific legal rights, and you may have other rights which vary from country to country.

For other information, please visit www.BenQ.com.

Copyright

Copyright © 2007 by BenQ Corporation. All rights reserved. No part of this publication may be reproduced, transmitted, transcribed, stored in a retrieval system or translated into any language or computer language, in any form or by any means, electronic, mechanical, magnetic, optical, chemical, manual or otherwise, without the prior written permission of BenQ Corporation.

*DLP, Digital Micromirror Device and DMD are trademarks of Texas Instruments. Others are copyrights of their respective companies or organizations.

Disclaimer

BenQ Corporation makes no representations or warranties, either expressed or implied, with respect to the contents hereof and specifically disclaims any warranties, merchantability or fitness for any particular purpose. Further, BenQ Corporation reserves the right to revise this publication and to make changes from time to time in the contents hereof without obligation of BenQ Corporation to notify any person of such revision or changes.

10. Regulation statements

FCC statement

CLASS B: This equipment generates, uses and can radiate radio frequency energy and, if not installed and used in accordance with the instructions, may cause harmful interference to radio communications. However, there is no guarantee that interference will not occur in a particular installation. If this equipment does cause harmful interference to radio or television reception, which can be determined by turning the equipment off and on, the user is encouraged to try to correct the interference by one or more of the following measures:

- Reorient or relocate the receiving antenna.
- Increase the distance between the equipment and receiver.
- Connect the equipment into an outlet on a circuit different from that to which the receiver is connected.
- Consult the dealer or an experienced radio/TV technician for help.

EEC statement

This machine was tested against the 89/336/EEC (European Economic Community) for EMC (Electronic Magnetic Compatibility) and fulfills these requirements.

MIC statement

B class equipment (Household purpose info/telecommunications equipment)

This equipment has undergone EMC registration for household purpose, and can be used in any area including residential area.

WEEE directive

Disposal of Waste Electrical and Electronic Equipment by users in private households in the European Union.

This symbol on the product or on the packaging indicates that this can not be disposed of as household waste. You must dispose of your waste equipment by handling it over to the applicable take-back scheme for the recycling of electrical and electronic equipment. For more information about recycling of this equipment, please contact your city office, the shop where you purchased the equipment or your household waste disposal service. The recycling of materials will help to conserve natural resources and ensure that it is recycled in a manner that protects human health and environment.

